

ICD-08635

# POPULAR COMMUNICATIONS

NOVEMBER 1985 \$1.95

\$2.50 CANADA

## Eavesdropping On International Terrorists

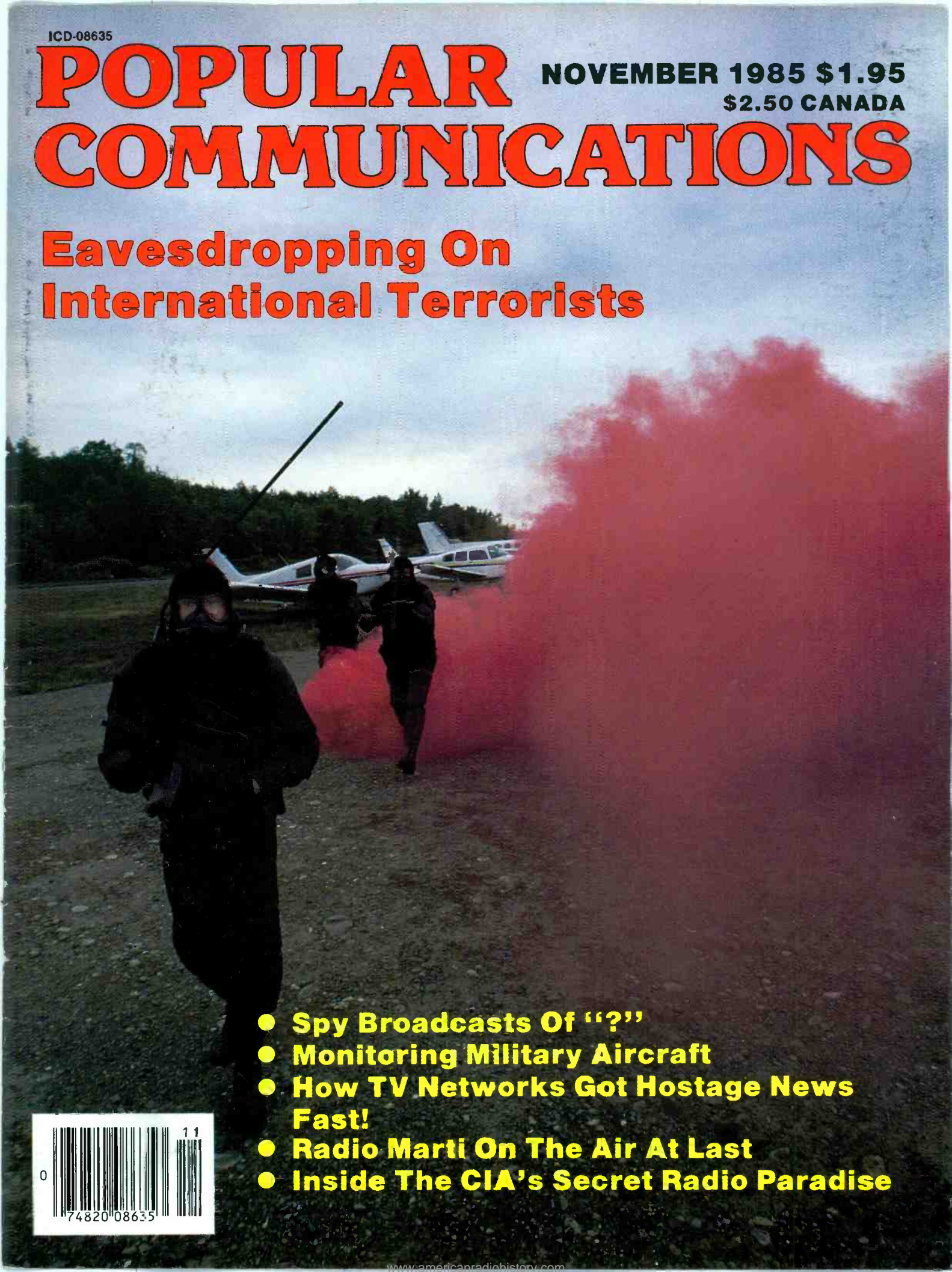
- 
- **Spy Broadcasts Of “?”**
  - **Monitoring Military Aircraft**
  - **How TV Networks Got Hostage News Fast!**
  - **Radio Marti On The Air At Last**
  - **Inside The CIA’s Secret Radio Paradise**





# KENWOOD

...pacesetter in Amateur radio

## Scan the World



### R-2000

#### All-mode receiver.

- Covers 150 kHz – 30 MHz in 30 bands.
- All mode: USB, LSB, CW, AM, FM.
- Digital VFO's. 50-Hz, 500-Hz or 5-kHz steps. F. LOCK switch.
- Ten memories store frequency, band, and mode data. Each memory may be tuned as a VFO.
- Lithium batt. memory back-up.
- Memory scan.
- Programmable band scan.
- Fluorescent tube digital display of frequency (100 Hz resolution) or time.
- Dual 24-hour quartz clocks, with timer.
- Three built-in IF filters with NARROW/WIDE selector switch. (CW filter optional.)
- Squelch circuit, all mode, built-in.
- Noise blanker built-in.
- Large front mounted speaker.
- RF step attenuator. (0-10-20-30 dB.)
- AGC switch. (Slow-Fast.)
- "S" meter, with SINPO scale.
- High and low impedance antenna terminals.
- 100/120/220/240 VAC operation.
- RECORD output jack.
- Timer REMOTE output (not for AC power).
- Muting terminals.

Specifications and prices subject to change without notice or obligation.



**R-1000** High performance receiver • 200 kHz-30 MHz in 30 bands • AM, CW, SSB • 3 IF filters • noise blanker • RF attenuator • S-meter • 120-240 VAC • muting terminals • built-in speaker • digital display/clock/timer



**R-600** General coverage receiver • 150 kHz-30 MHz in 30 bands • AM, CW, SSB • IF filters • noise blanker • RF attenuator • S-meter with SINPO scale • front mounted speaker • 3 antenna inputs • 100-240 VAC operation • record jack • muting terminals • digital display

#### Optional accessories:

- VC-10 VHF converter for R-2000 covers 118-174 MHz
- YG-455C 500 Hz CW filter for R-2000
- HS-4 Headphones
- HS-5 Deluxe headphones
- HS-6 Lightweight headphones
- HS-7 Micro headphones
- DCK-1 DC cable kit for 13.8 VDC operation
- AL-2 Lightning and static arrester
- Service manuals are available for all receivers and most accessories.

Additional information on Kenwood all-band receivers is available from authorized dealers.

# KENWOOD

TRIO-KENWOOD COMMUNICATIONS  
1111 West Walnut Street  
Compton, California 90220  
CIRCLE 139 ON READER SERVICE CARD



"The Largest Dealer of Scanners in the World"



# SCANNER WORLD, USA

10 New Scotland Ave., Albany, NY 12208 518/436-9606

**Special SALE!**

## The Regency Z30

### 30 Channel Automatic/Programmable Scanner

#### Z30 FEATURES:

- **30 Channels**—For full coverage and easy selection.
- **No Crystals Required**—Your choice of over 15,000 frequencies just by pushing a raised type button on the keyboard face.
- **6 Bands**—Covers high and low VHF, UHF and UHF "T" plus two FM Ham Bands.
- **Search or Scan**—Scan frequencies you have entered or search for exciting new frequencies.
- **Priority Control**—Automatically overrides all other calls to listen to your favorite frequency.
- **Alarm Clock**—Quartz Clock with programmable alarm.
- **Permanent Backup System**—Memory requires no batteries. Capacitor saves frequencies entered up to one week during power outage or storage.
- **Dual Level Display**—Selects brightness level of green vacuum fluorescent digital display.
- **Channel Lockout**—Skips channels not of current interest.
- **Scan Delay**—Lets you set a delay so that replies to calls will be heard before scanning resumes.
- **Display Messages**—Display flashes verbal messages to aid in programming.
- **External Antenna Jack**—Permits maximum reception range.
- **External Speaker Jack**—Standard connection allows use of external speaker.
- **AC or DC**—Use at home or on the go. AC Home Power Cord Included.
- **Telescoping Antenna**—Electronically optimized for all frequencies, included.
- **UL Listed/FCC Certified Assurance** of quality, American made design and manufacturer, made in USA.

Suggested Factory List Price \$279.95

#### Scanner World Special

**\$129.99**

(plus \$5.50 Shipping)

#### REGENCY Z30

##### Optional:

- Cigarette Lighter Plug RGMPG \$4.95
- Z Mobile Mounting Bracket (Available Soon) \$9.99

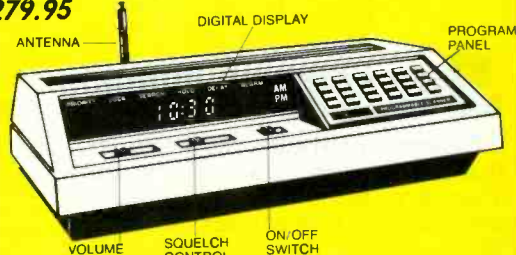

The Regency Z30 is a compact, programmable 30 channel, multi band, FM monitor receiver for use at home or on the road. It is double conversion,

super heterodyne used to receive the narrow band FM communications in the amateur, public safety and business bands: 30-50, 144-174, and 440-512 MHz. Size 10 3/4" Wx2-7/8" Hx8-3/8" D.

Sophisticated microprocess-controlled circuitry eliminates the need for crystals, instead, the frequency for each channel is programmed through the numbered keyboard similar to the one used on a telephone. A "beep" acknowledges contact each time a key is touched. The Z30 scans approximately 15 channels per second.

Any combination of two to thirty channels can be scanned automatically, or the unit can be set on manual for continuous monitoring of any one channel. In addition, the search function locates unknown frequencies within a band.

Other features include scan delay, priority and a bright/dim switch to control the brightness of the 9-digit Vacuum-Fluorescent display. The Z30 can be operated on either 120 VAC or 12VDC. One year warranty from Regency Electronics. (3 years extended warranty only \$35.00, gives you a total of 4 years complete warranty.)

CIRCLE 154 ON READER SERVICE CARD

#### EXTENDED WARRANTY PROGRAM 3 EXTRA YEARS — ONLY \$35.00

Scanner World is pleased to offer extended warranty protection on your scanner purchases. For a one time charge of only \$35.00, we will provide you with 3 additional years of warranty protection after your original warranty expires. Extended warranty program is available for all types of electronics such as two-way radios, scanners, TVs, VCR, 35mm cameras, personal computers, CBs, radar detectors, stereo equipment, etc. Scanner World can offer this program to all customers, even if product was not purchased from Scanner World. All we need is a copy of your invoice showing purchase within last 30 days. For more information and rates, refer to our 1985 Winter Catalogue or drop us a note.

#### REGENCY HX1000 • Hand-Held

Programmable, 30 Channel, Hi-Lo UHF, Package includes charger/adaptor, Ni-Cad battery, Carry Case, Rubber Antenna. Complete package only...

**\$204.99** (6.50 shipping)  
(3 year extended warranty only \$35.00)

#### REGENCY RH-256B

##### PROGRAMMABLE TRANSCEIVER

RH-256B Transceiver, 16 channel 12 VDC 2-way Radio fully programmable in transmit and receive mode. Includes built-in CTCSS tones for encode/decode, time-out timer, scan delay, 25 watts transmit power, priority, plus more. Frequency spread as shipped 152-158 MHz. Package includes mobile mike, bracket, mobile antenna, and all cables and instructions for installation. **Special package deal only: \$399.99** (7.75 shipping)

#### Bearcat 100 XL

\$214.99 (6.50 shipping) Handheld digital programmable, no crystal portable scanner. 16 channels, search feature, plus more! Frequency range: 30-50, 118-174, 406-512 MHz. Included in the package is a flexible rubber antenna, earphone, battery charger/AC adapter, 6 AA Ni-Cad rechargeable batteries and a heavy duty carry case. All for the low price of:

(3 year extended warranty only \$35.00) **\$214.99** (6.50 shipping)

#### JIL SX-200 • AC/DC

High-Low-UHF-Aircraft-16 Channel  
only **\$158.99** (6.75 shipping)

#### Ordering Information

Call (518) 436-9606 to place orders by phone or mail orders to Scanner World, 10 New Scotland Ave., Albany, NY 12208. Orders will be shipped same day received by United Parcel Service. Scanner World accepts VISA, MasterCard. C.O.D. shipments by United Parcel will be for cash or certified checks only. Mail orders with personal or business checks will be held 4 weeks for bank clearance. Orders with cashiers checks or money orders shipped same day received. Prices, specifications and terms subject to change without prior notice. If items are out of stock we will backorder and notify you of delivery date. All shipments are FOB Scanner World warehouse in Albany, NY. We are not responsible for typographical errors. All merchandise carries full manufacturers warranty. Bid Proposals and Purchase orders accepted from Government agencies. Free full line catalogue available upon request. No minimum order. New York State Residents add 7% sales tax. Dealers send business letterhead for dealer wholesale information.

#### SHIPPING CHARGES

Add (\$ per scanner, and \$3.00\* for all accessories ordered at same time. C.O.D. shipments will be charged an additional \$3.00 per package. Full insurance is included in shipping charges. All orders are shipped by United Parcel Service. Shipping charges are for continental USA only. Outside of continental USA, add \$15.00 per scanner.

#### Scanner World, USA

10 New Scotland Ave., Albany, NY 12208

(518) 436-9606

Most orders Shipped Same Day Received!

BEARCAT 100XL Digital Hand Held	214.99 (6.50)
BEARCAT 210XW AC/DC Digital Scanner	214.99 (6.50)
BEARCAT 5 AC Crystal Scanner	94.99 (4.00)
BEARCAT Five-Six Crystal, hand held	126.99 (4.00)
BEARCAT 15 AC/DC Crystal Scanner	126.99 (4.00)
BEARCAT 180 AC Digital Scanner	159.99 (4.00)
BEARCAT 200 AC Digital Scanner	172.99 (5.00)
BEARCAT 201 AC Digital Scanner	179.99 (5.50)
BEARCAT 201/20 AC/DC Digital Scanner	279.99 (5.50)
BEARCAT 260 AC/DC Digital Scanner	278.99 (4.00)
BEARCAT 300 AC/DC Digital Scanner	346.99 (7.00)
BEARCAT 800 XLT AC/DC Digital Scanner	319.99 (6.00)
BEARCAT DX-1000 Shortwave Receiver	499.99 (12.00)
REGENCY D-310 AC/DC Digital Scanner	129.99 (4.50)
REGENCY HX-1000 Digital Hand Held	204.99 (6.50)
REGENCY MA-256 Drop in Charger for 1000	69.99 (3.50)
REGENCY HX-2000 Digital Hand Held	349.99 (6.50)
REGENCY MX-3000 AC/DC Digital Scanner	198.99 (6.50)
REGENCY MX-4000 AC/DC Digital Scanner	179.99 (6.50)
REGENCY MX-5000 AC/DC Digital Scanner	369.99 (6.50)
REGENCY MX-7000 AC/DC Digital Scanner	469.99 (7.00)
REGENCY Z-10 AC/DC Digital Scanner	146.99 (5.00)
REGENCY Z-30 AC/DC Digital Scanner	129.99 (5.50)
REGENCY Z-45 AC/DC Digital Scanner	209.99 (5.00)
REGENCY Z-60 AC/DC Digital Scanner	239.99 (5.50)

#### Mobile Mounting Bracket

For Z Scanner (available soon)	9.99 (3.00)
REGENCY HX-650 Complete Package Deal	109.99 (5.50)
REGENCY D-810 AC Digital Scanner	199.99 (5.50)
REGENCY R-1040 AC Programmable Scanner	99.99 (5.00)
REGENCY R-1050 AC Programmable Scanner	114.99 (5.00)
REGENCY C-403 AC Crystal Scanner	66.99 (4.00)
REGENCY ACT-R-106 AC/DC Crystal Scanner	96.99 (3.50)
REGENCY ACT-R-1 AC/DC Crystal Single Channel	75.99 (4.00)
REGENCY RH-256 High Band Transceiver	399.99 (7.75)
RCD MRP-1 Single Channel Hand Held	38.99 (3.00)
JIL SX-200 AC/DC Digital Scanner	158.99 (6.75)
JIL SX-400 DC Digital Scanner	539.99 (12.00)
FANON M8HLU DC Crystal Scanner	99.99 (4.00)
Fanion PSK-1 AC Adapted for M8HLU	12.99 (3.00)
Fanion Slim-6 HLU Crystal Hand Held Scanner	103.99 (4.00)
FOX BMP-1060 AC/DC Digital Scanner	149.99 (5.50)
FOX Mounting Bracket for BMP-1060	8.99 (3.00)
Whistler Spectrum Radar Detector	219.99 (4.50)
Whistler Remote Spectrum Radar Detector	219.99 (4.50)

#### Super Special Package Sale REGENCY HX-650

##### Pocket Scanner

##### 6 CHANNELS — 4 BANDS

VHF-Low	30 to 50 MHz
VHF-High	146 to 174 MHz
UHF	450 to 470 MHz
UHF-T	470 to 512 MHz
Small Size	3 3/4" Wx5 1/2" Hx1" D

Quality features included in the Regency HX-650 are 6 channels - 4 band coverage, lockout switches, manual step switch, scanning speed of 15 channels per second, long lasting LEDs, volume & squelch controls, AC adapter/charger jacks.

#### Scanner World's Special Package Deal

Includes the following:

- Regency HX-650 Pocket Scanner
- MA-506 Carry Case with metal belt clip
- Set of 4AAA Nickel Cadmium Batteries
- E Monitor Crystals (specify frequencies needed or we will include certificates for unknown frequencies)
- Flexible Rubber Duckey Antenna

#### Scanner World Package Price

**\$109.99**

(Plus \$5.50 Shipping)





# NEW!

# uniden® Bearcat®

# Regency®

## Scanners

Communications Electronics,™ the world's largest distributor of radio scanners and scanner accessories from J.I.L., Regency and also Uniden/Bearcat. Chances are the police, fire and weather emergencies you'll read about in tomorrow's paper are coming through on a scanner today.

**NEW! Regency® MX7000-K**  
List price \$699.95/CE price \$429.00/SPECIAL 10-Band, 20 Channel • Crystalless • AC/DC  
Frequency range: 25-550 MHz. continuous coverage and 800 MHz. to 1.2 GHz. continuous coverage  
In addition to normal scanner listening, the MX7000 offers CB, VHF, and UHF TV audio, FM Broadcast, all aircraft bands (civil and military), 800 MHz communications, cellular telephone, and when connected to a printer or CRT, satellite weather pictures.

**NEW! Regency® MX5000-K**  
List price \$599.95/CE price \$329.00/SPECIAL Multi-Band, 20 Channel • No-crystal scanner Search • Lockout • Priority • AC/DC Selectable AM-FM modes • LCD display World's first continuous coverage scanner  
Frequency range: 25-550 MHz. continuous coverage.  
Never before have so many features come in such a small package. The Regency MX5000 mobile or home scanner has continuous coverage from 25 to 550 MHz. That means you can hear CB, Television audio, FM broadcast stations, all aircraft bands including military and the normal scanner bands, all on your choice of 20 programmable channels.

**NEW! Regency® MX4000-K**  
List price \$629.95/CE price \$299.00/SPECIAL Multi-Band, 20 Channel • No-crystal scanner Search • Lockout • Priority • AC/DC Selectable AM-FM modes • LCD display  
Bands: 30-50, 118-136, 144-174, 440-512, 800-950 MHz.  
The Regency MX4000 is gives coverage in the standard VHF and UHF ranges with the important addition of the 800 MHz, and aircraft bands. It features keyboard entry, multifunction liquid crystal display and variable search increments.

**NEW! Regency® Z60-K**  
List price \$379.95/CE price \$216.00/SPECIAL 8-Band, 60 Channel • No-crystal scanner  
Bands: 30-50, 88-108, 118-136, 144-174, 440-512 MHz.  
Cover your choice of over 15,000 frequencies on 60 channels at the touch of your finger.

## NEW! JIL SX-400-K

List price \$799.95/CE price \$469.00/SPECIAL Multi-Band, 20 Channel • No-crystal Scanner Search • Lockout • Priority • AC/DC  
Frequency range: 26-520 MHz. continuous coverage.  
With optionally equipped RF converters 150KHz-3.7 GHz. The JIL SX-400 synthesized scanner is designed for commercial and professional monitor users that demand features not found in ordinary scanners. The SX-400 will cover from 150 KHz to 3.7 GHz. with RF converters. Order the following RF converters for your SX-400 scanner. RF-1030-K at \$259.00 each for frequency range 150 KHz - 30 MHz. USB, LSB, CW and AM. (CW filter required for CW signal reception); RF-5080-K at \$199.00 each for 500-800 MHz.; RF-8014-K at \$199.00 each for 800 MHz.-1.4 GHz. Be sure to also order ACB-300-K at \$99.00 each which is an antenna control box for connection of the RF converters. The RC-4000-K data interface at \$259.00 each gives you control of the SX-400 scanner and RF converters through a computer. Add \$3.00 shipping for each RF converter, data interface or antenna control box. If you need further information on the JIL scanners, contact JIL directly at 213-926-6727 or write JIL at 17120 Edwards Road, Cerritos, California 90701 U.S.A.

## SPECIAL! JIL SX-200-K

List price \$499.95/CE special price \$159.00 Multi-Band - 16 Channel • No-Crystal Scanner  
Frequency range 26-88, 108-180, 380-514 MHz  
The JIL SX-200 scanner tunes military, F.B.I., Space Satellites, Police and Fire, Drug Enforcement Agencies, Defense Department, Aeronautical AM band, Aero Navigation Band, Fish & Game, Immigration, Paramedics, Amateur Radio, Justice Department, State Department, plus other thousands of radio frequencies most other scanners can't pick up. The SX-200 has selectable AM/FM receiver circuits, tri-switch squelch settings - signal, audio and signal & audio, outboard AC power supply - DC at 12 volts built-in, quartz clock - bright vacuum fluorescent blue readouts and dimmer, dual level search speeds, tri-level scan delay switches, 16 memory channels in two channels banks, receive fine tune (RIT) ± 2KHz., dual level RF gain settings - 20 db pad, AGC test points for optional signal strength meters.

## Regency® HX1000-K

List price \$329.95/CE price \$209.00 6-Band, 30 Channel • No Crystal Scanner Search • Lockout • Priority • Scan delay Sidelit liquid crystal display • Digital Clock  
Frequency range: 30-50, 144-174, 440-512 MHz.  
The new handheld Regency HX1000 scanner is fully keyboard programmable for the ultimate in versatility. You can scan up to 30 channels at the same time. When you activate the priority control, you automatically override all other calls to listen to your favorite frequency. The LCD display is even sidelit for night use. Order MA-256-K rapid charge drop-in battery charger for \$79.00 plus \$3.00 shipping/handling. Includes wall charger, carrying case, belt clip, flexible antenna and nicad battery. Order now.

## NEW! Bearcat® 100XL-K

List price \$349.95/CE price \$229.00 9-Band, 16 Channel • Priority • Scan Delay Search • Limit • Hold • Lockout • AC/DC  
Frequency range: 30-50, 118-174, 406-512 MHz.  
The world's first no-crystal handheld scanner now has a LCD channel display with backlight for low light use and aircraft band coverage at the same low price. Size is 1 3/4" x 7 1/2" x 2 1/4". The Bearcat 100XL has wide frequency coverage that includes all public service bands (Low, High, UHF and "T" bands), the AM aircraft band, the 2-meter and 70 cm. amateur bands, plus military and federal government frequencies. Wow... what a scanner!  
Included in our low CE price is a sturdy carrying case, earphone, battery charger/AC adapter, six AA ni-cad batteries and flexible antenna. Order your scanner now.

## NEW! Regency® HX2000-K

The World's First 800 MHz. Handheld Scanner  
List price \$569.95/CE price \$359.00 7-Band, 20 Channel • No-crystal scanner Priority control • Search/Scan • AC/DC Sidelit liquid crystal display • Memory backup  
Bands: 118-136, 144-174, 440-512, 800-950 MHz.  
The HX2000 scanner operates on 120V AC or 6 VDC. Scans 15 channels per second. Size 3" x 7" x 1 1/2". Includes wall charger, carrying case, belt clip, flexible antenna and nicad batteries. Selectable AM/FM modes.

## NEW! Bearcat® 800XLT-K

List price \$499.95/CE price \$329.00 12-Band, 40 Channel • No-crystal scanner Priority control • Search/Scan • AC/DC  
Bands: 29-54, 118-174, 406-512, 806-912 MHz.  
The Uniden 800XLT receives 40 channels in two banks. Scans 15 channels per second. Size 9 1/4" x 4 1/2" x 1 1/2".

### OTHER RADIOS AND ACCESSORIES

Panasonic RF-2800-K Shortwave receiver	\$179.00
Panasonic RF-B300-K Shortwave receiver	\$195.00
RD95-K Uniden Remote mount Radar Detector	\$139.00
RD55-K Uniden Visor mount Radar Detector	\$119.00
BC 20/20-K Bearcat 40 channel scanner	\$274.00
BC 210XW-K Bearcat 20 channel scanner	\$219.00
BC-WA-K Bearcat Weather Alert	\$39.00
DX1000-K Bearcat shortwave receiver	\$459.00
PC22-K Uniden remote mount CB transceiver	\$99.00
PC55-K Uniden mobile mount CB transceiver	\$59.00
Z10-K Regency 10 channel scanner	\$139.00
Z30-K Regency 30 channel scanner	\$154.00
Z45-K Regency 45 channel scanner	\$179.00
R1060-K Regency 10 channel scanner	\$98.95
MX3000-K Regency 30 channel scanner	\$189.00
C403-K Regency 4 channel scanner	\$69.00
R106-K Regency 10 channel scanner	\$99.00
RH250B-K Regency 10 channel VHF transceiver	\$329.00
RU150B-K Regency 10 channel UHF transceiver	\$449.00
RPH410-K 10 ch. handheld no-crystal transceiver	\$399.00
BC10-K Battery charger for Regency RPH410	\$79.00
MA256-K Drop-in charger for HX1000 scanner	\$79.95
MA257-K Cigarette lighter cord for HX1000	\$19.95
MA917-K Ni-Cad battery pack for HX1000	\$24.95
EC10-K Programming tool for Regency RPH410	\$20.00
SMRH250-K Service man. for Regency RH250	\$20.00
SMRU150-K Service man. for Regency RU150	\$20.00
SMRPH410-K Service man. for Regency RPH410	\$20.00
SMMX7000-K Svc. man. for MX7000 & MX5000	\$20.00
SMMX3000-K Service man. for Regency MX3000	\$20.00
B-4-K 1.2 V AAA Ni-Cad batteries (set of four)	\$9.00
A-135C-K Crystal certificate	\$3.00
FB-E-K Frequency Directory for Eastern U.S.A.	\$12.00
FB-W-K Frequency Directory for Western U.S.A.	\$12.00
TSG-K "Top Secret" Registry of U.S. Govt. Freq.	\$15.00
TIC-K Techniques for Intercepting Comm.	\$15.00
RRF-K Railroad frequency directory	\$10.00
CIE-K Covert Intelligenc. Elect. Eavesdropping	\$15.00
A60-K Magnet mount mobile scanner antenna	\$35.00
A70-K Base station scanner antenna	\$35.00
USAMM-K Mag mount VHF/UHF ant. w/ 12' cable	\$39.95
USAK-K 3/4" hole mount VHF/UHF ant. w/ 17' cable	\$35.95
USATLM-K Trunk lip mount VHF/UHF antenna	\$35.95

Add \$3.00 shipping for all accessories ordered at the same time.  
Add \$12.00 shipping per shortwave receiver.  
Add \$7.00 shipping per scanner and \$3.00 per antenna.

### BUY WITH CONFIDENCE

To get the fastest delivery from CE of any scanner, send or phone your order directly to our Scanner Distribution Center™ Michigan residents please add 4% sales tax or supply your tax I.D. number. Written purchase orders are accepted from approved government agencies and most well rated firms at a 10% surcharge for net 10 billing. All sales are subject to availability, acceptance and verification. All sales on accessories are final. Prices, terms and specifications are subject to change without notice. All prices are in U.S. dollars. Out of stock items will be placed on backorder automatically unless CE is instructed differently. A \$5.00 additional handling fee will be charged for all orders with a merchandise total under \$50.00. Shipments are F.O.B. Ann Arbor, Michigan. No COD's. Most products that we sell have a manufacturer's warranty. Free copies of warranties on these products are available prior to purchase by writing to CE. Non-certified checks require bank clearance.

Mail orders to: Communications Electronics,™ Box 1045, Ann Arbor, Michigan 48106 U.S.A. Add \$7.00 per scanner for U.P.S. ground shipping and handling in the continental U.S.A. For Canada, Puerto Rico, Hawaii, Alaska, or APO/FPO delivery, shipping charges are three times continental U.S. rates. If you have a Visa or Master Card, you may call and place a credit card order. Order toll-free in the U.S. Dial 800-USA-SCAN. In Canada, order toll-free by calling 800-221-3475. Telex CE anytime, dial 810-223-2422. If you are outside the U.S. or in Michigan dial 313-973-8888. Order today.

Scanner Distribution Center™ and CE logos are trademarks of Communications Electronics Inc.  
† Bearcat is a registered trademark of Uniden Corporation.  
‡ Regency is a federally registered trademark of Regency Electronics Inc. AD #090385-K  
Copyright © 1985 Communications Electronics

## For credit card orders call 1-800-USA-SCAN

# COMMUNICATIONS ELECTRONICS INC.

Consumer Products Division  
P.O. Box 1045 □ Ann Arbor, Michigan 48106-1045 U.S.A.  
Call 800-USA-SCAN or outside U.S.A. 313-973-8888

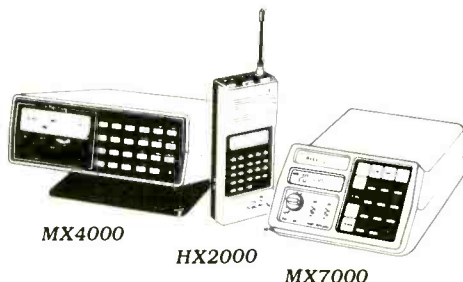
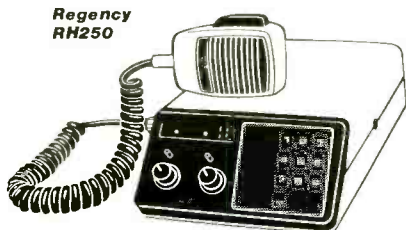

**EDITORIAL STAFF**  
 Tom Kneitel, K2AES  
 Editor  
 Anita Hippius  
 Associate Editor

**CONTRIBUTING EDITORS**  
 Gerry L. Dexter  
 Shortwave Broadcast  
 Robert Margolis  
 RTTY Monitoring  
 Gordon West, WB6NOA  
 Survivalist Communications  
 Mike Chabak  
 Utility Communications  
 Don Schimmel  
 Ute Intercepts  
 Darren Leno, WD0EWJ  
 Alternative Radio  
 Harold A. Ort, Jr.  
 Military Consultant  
 Janice Lee  
 Radar Detectors  
 Chuck Gysi, N2DUP  
 Scanners  
 Julian Macassey  
 Telephone Accessories  
 Mark J. Manucy, W3GMG  
 AM/FM Broadcasts  
 Ed Noll  
 Antennas

**BUSINESS STAFF**  
 Richard A. Ross, K2MGA  
 Publisher  
 Herb Pressman, KA2UGV  
 Advertising Manager  
 Dorothy Kehrwieler  
 General Manager  
 Arlene Caggiano  
 Accounting  
 Cheryl Chomicki  
 Subscriber Services

**PRODUCTION STAFF**  
 Elizabeth Ryan  
 Art Director  
 Barbara Scully  
 Artist  
 Dorothy Kehrwieler  
 Production Manager  
 Gail M. Schieber  
 Production Assistant  
 Pat Le Blanc  
 Richard Kishanuk  
 Phototypographers  
 Hal Keith  
 Technical Illustrator  
 Larry Mulvehill, WB2ZPI  
 Contributing Photographer

# POPULAR COMMUNICATIONS

NOVEMBER 1985

VOL. 4, NO.3



16



24



26

## FEATURES

- The Amazing Log Of Radio Marti** 8  
 It took more than three years to put it on the air! But now it's here for better or worse. It's Radio Swan's well-behaved offspring. *by Gerry L. Dexter*
- Spy Numbers Transmissions** 12  
 Spy or "?" The mystery continues. Here are the latest theories, guesses, and ideas from our resident expert. *by Robert M. Dyquetta*
- Inside The CIA's Secret Radio Paradise: Part I** 16  
 The CIA's pride and joy—a 50 kW clandestine broadcaster "hidden" right out in the open! It was Radio Marti's daddy. *by Tom Kneitel, K2AES, Editor*
- Monitoring International Terrorists** 24  
 Each terrorist crisis produces a flood of communications! Eavesdropping on them is informative and exciting. *by Anton Kuchacevich ze Schluderpacheru*
- Olde Time Radio** 26  
 A look back into earlier days. *by Alice Brannigan*
- Books You'll Like** 32  
 We recommend: *The Incredible Dial-A-Message Directory; Direct Sequence Spread Spectrum Techniques; Hi, I'm Johnny Sandison; Intelligence Warfare; World Broadcast Station Address Book*
- Low Band Military Aero Scanning** 34  
 The VHF "Low Band" still has mysteries to reveal! Here are some of those mysteries and how you can tune them in. *by Rick Maslau, KNY2GL*
- How The Networks Got The Hostage News** 45  
 A first hand report explaining how American TV networks got the hostage news via artificial satellite. *by Lance McGraw*

*This month's cover: Counterr group instructors J. Keith Idema, Charles Conger, Ray Carney, and William Aylward during a hostage rescue operation. Photographed with the cooperation of Counterr Group Police Academy, Poughkeepsie, New York. Photo by Larry Mulvehill, WB2ZPI.*

## DEPARTMENTS

Beaming In . . . . .	4	Listening Post . . . . .	52
Mailbag . . . . .	6	Broadcast Topix . . . . .	56
Scanner Scene . . . . .	36	Washington Pulse . . . . .	59
Survival . . . . .	38	On The Line . . . . .	60
POP'COMM Products . . . . .	41	Communications Confidential . . . . .	62
RTTY Monitoring . . . . .	42	Pirates Den . . . . .	72
Better Signals . . . . .	50	Communications Shop . . . . .	74

Offices: 76 North Broadway, Hicksville, NY 11801. Telephone 516 681-2922. Popular Communications (ISSN 0733-3315) is published monthly by Popular Communications, Inc. Corporate officers: Richard A. Ross, Pres.; Thomas S. Kneitel, Vice Pres.; Alan M. Dorhoffer, Secretary. Second class postage paid at Hicksville, NY and additional offices. Subscription prices: Domestic—one year \$14.00, two years \$25.00, three years \$36.00. Canada/Mexico—one year \$16.00, two years \$29.00, three years \$42.00. Foreign—one year \$18.00, two years \$33.00, three years \$48.00. Foreign Air Mail—one year \$71.00, two years \$139.00, three years \$207.00. Entire contents copyright ©1985 by Popular Communications, Inc. Popular Communications assumes no responsibility for unsolicited manuscripts, photographs, or drawings. Allow six weeks for change of address or delivery of first issue. Printed in the United States of America.  
 Postmaster: Please send change of address to Popular Communications, 76 North Broadway, Hicksville, NY 11801.



# RECEIVE RTTY/ASCII/CW on your Personal Computer



**RTTY/ASCII/CW  
SWL COMPUTER INTERFACE** MFJ-1225  
\$ 69.95

**FREE MFJ RTTY/ASCII/CW Software**  
TAPE AND CABLE FOR VIC-20 OR C-64. ORDER MFJ-1225/  
MFJ-1264 FOR VIC-20 OR MFJ-1225/MFJ-1265 FOR C-64.

Receives commercial, military, and amateur RTTY/ASCII/CW using your personal computer.

The MFJ-1225 Computer Interface plugs between your receiver and VIC-20, Apple, TRS-80C, Atari, TI-99, Commodore 64 and most other personal computers. Requires appropriate software.

Copies all shifts (850, 425, 170 Hz shift and all others) and all speeds. Automatic noise limiter suppresses static crashes for better copy. 2 LED tuning indicator makes tuning fast, easy, positive. 4 1/2 x 1 1/4 x 4 1/4 in. 12-15 VDC or 110 VAC with optional adapter, MFJ-1312. \$9.95.

## INDOOR TUNED ACTIVE ANTENNA

MFJ-1020  
\$ 79.95



MFJ-1020 New Indoor Active Antenna sits on your desk ready to listen to the world. Rivals, often exceeds, reception of outside long wire. Unique Tuned Active Antenna minimizes intermode, provides RF selectivity, reduces noise outside tuned band. Also use as preselector for external antenna. Covers 300 KHz to 30 MHz in 5 bands. Adjustable telescoping antenna. Controls: Tune, Band Selector, Gain, ON-Off/Bypass. LED. FET, bipolar circuitry. Phone jack for external ant. 6x2x6 in. 9-18 VDC or 9V battery. 110 VAC with adapter, MFJ-1312. \$9.95.

## REMOTE ACTIVE ANTENNA

54 inch remote active antenna mounts outdoor away from electrical noise for maximum signal and minimum noise pickup. Often outperforms longwire hundreds of feet long. Mount anywhere - atop houses, buildings, balconies, apartments, mobile homes, on board ship.

Use with any radio to receive strong clear signals from all over the world. 50 KHz to 30 MHz.

High dynamic range eliminates intermodulation. Inside control unit has 20 dB attenuator, gain control. Switch 2 receivers and auxiliary or active antenna. "On" LED. 6x2x5 in. 50 ft. coax. 12 VDC or 110 VAC with MFJ-1312, \$9.95.



MFJ-1024  
\$ 129.95

Order from MFJ and try it. If not delighted, return within 30 days for refund (less shipping).

One year unconditional guarantee.

Order yours today. Call toll free 800-647-1800. Charge VISA, MC. Or mail check, money order. Add \$4.00 each for shipping and handling.

**CALL TOLL FREE 800-647-1800**

Call 601-323-5869 in Miss., outside continental USA, tech/order/repair info. TELEX 53-4590

**MFJ ENTERPRISES,  
INCORPORATED**  
Box 494, Mississippi State, MS 39762

# BEAMING IN

BY TOM KNEITEL, K2AES

## AN EDITORIAL

It will be interesting to see the FCC's reaction to RM-5038, the ARRL proposal to increase the operating privileges for Novice Class ham operators. Presently, Novices are permitted only CW operation, and only on the 10, 15, 40, and 80 meter bands. The old 2-meter voice privileges for Novices were cancelled back in 1968.

The ARRL's new proposal seeks to convince the FCC that Novices should be given the right to communicate by voice in order to make ham radio more appealing to newly licensed operators so that they will "upgrade to a higher class of license." The ARRL would also like to see some additional non-voice rights granted to Novices.

Radioteletype and packet radio privileges (to attract young people interested in computers and digital communications) are suggested for 28.10 to 28.3 MHz. Low power SSB operation is proposed for 28.30 to 28.50 MHz. A 25-watt authorization for voice/data operation on the 220 MHz band, in conjunction with repeaters, would be authorized. Low power (5 watt) operations from 1246 to 1260 MHz would also be in effect under the ARRL proposal.

We think that RM-5038 is a fine idea and only wish it had come along about 5 years down the line when 27 MHz SSB operators were beginning to chafe at the "goodbuddy" type of operation noted on the AM CB channels. These operators begged the FCC for their own frequencies away from the "10-4" crowd. When the long-awaited channels were added to CB (27.265 to 27.405 MHz), they were for combined AM and SSB operations. The SSB operators would have probably been very receptive to a beginner's grade ham ticket that offered voice communications on 28 MHz, but it never jelled. Some of these operators became bootleggers on unauthorized frequencies, others quit in disgust, and some did take out ham licenses—but only a relatively small portion of those who might have provided a gigantic influx of potentially good hams.

Hopefully the FCC will go along with RM-5038.

### "Evil" Electronics?

We electronics hobbyists elicit the strangest reactions from the general public you ever imagined. Your Uncle Ed can pour over his stamp or coin collection for a dozen hours per week and not one eyebrow is raised in suspicion about his mental health or motives. Folks can jog to the point of physical exhaustion and few persons would suggest that it's less than a great way of disposing of leisure time. And so it goes with flyers, boaters, butterfly collectors, baseball card fanatics, etc.

Once I knew a model train collector who pursued his avocation to the point where he literally foamed at the mouth at the mere hint of a Lionel or American Flyer hidden away in someone's attic—and yet even he was occasionally accepted as a member of polite society.

You could own the most outrageous camera in the world, complete with f-stops, exotic shutter speeds, telephoto lens, automatic film advance, and even a little re-

(Continued on page 70)

The Young Electronics Genius as seen by:

Mom & Dad

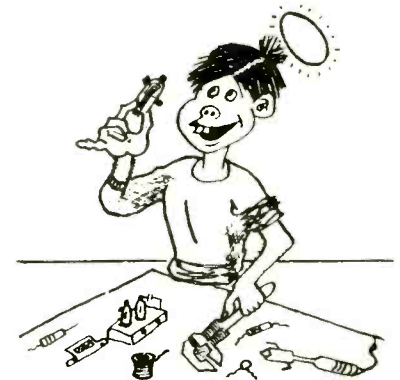

75-meter band ops



The neighbors

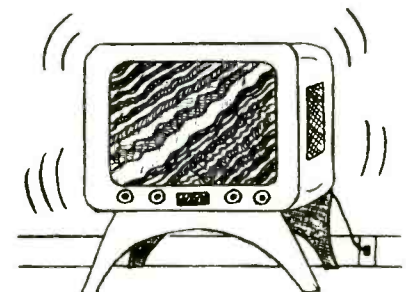



# You may not be able to solve the world's problems. But at least you can listen.



## The Panasonic Command Series™. With double superheterodyne tuning, you'll hear the world loud and clear.

Now it's easy to listen in on the world's hot spots. With the Panasonic RF-B600 Command Series FM/LW/MW/SW receiver.

Its advanced microcomputer-controlled tuner lets you preset up to nine different frequencies. And reach them at the touch of a button. Or, press the appropriate buttons and tune in any desired frequency with direct-access digital tuning. It'll lock right in to every signal with a PLL quartz-synthesized tuner. Once tuned in, the Panasonic double superheterodyne system helps deliver a clean, consistent signal.

There's even built-in auto-tuning to let you scan the shortwave band automatically, as well as manually. All this means you can tune in Berlin, pick up Paris, or locate London in an instant. Without dialing all over the band.

Both the RF-B600 and the RF-B300 are packed with features and built to go anywhere.

The Panasonic Command Series offers something for everyone. With equipment sophisticated enough to impress the most avid enthusiast, and automatic features that get you where you want to be. **Fast.**

There's a whole world out there that's waiting to be heard. Tune in to it with the Panasonic Command Series.



Batteries not included.

CIRCLE 81 ON READER SERVICE CARD

**Panasonic**  
just slightly ahead of our time.™



# MAILBAG LETTERS TO THE EDITOR

The most interesting questions we receive will be answered here in each issue. Address your questions to: Tom Kneitel, Editor, Popular Communications magazine, 76 North Broadway, Hicksville, NY 11801.

## Bootlegger Topix

Just before my July issue arrived I tuned up my ham rig on the 80 meter band. When I went to 3900 kHz to check my calibration it put me close to 3895 kHz, a frequency I avoid. I'm not a prude and have a few skeletons in my own closet, but what I've heard on 3895 kHz really ticks me off. So I was thrilled to learn in the July POP'COMM that the FCC is finally getting around to doing something. Last night the ominous membership all received their copies of POP'COMM and it was the main topic of conversation. Needless to say they were not at all pleased with Harry Caul's story. Many of the mavericks boasted about all of the mail they would be forwarding to POP'COMM. Let me express my appreciation for reporting on this matter and calling to the full attention of the radio world that this is not the way most hams operate. I hope that your story will help to clear up this situation.

Bud Sunkel, WA9HLP  
Danville, IL

I was surprised and shocked by your July story by Mr. Caul about the ham outlaws. Sorry, but I didn't bat an eyelash. Until 1960 most hams were former SWL's. After 1960 most hams were former CB'ers. Guess where they learned their manners? The "spark forever" crowd were able to defeat the FCC's proposed no-code ham license and that recent event may have made many would-be hams say "to hell with the FCC." Thus they simply moved on to the bands in force to take them over by sheer numbers. The FCC doesn't have the manpower or resources to deal with them in large numbers. Also there are as many licensed troublemakers on the ham bands today as unlicensed ones. My advice to SWL's is to stay out of it; it's not our problem. It's between the hams, the outlaws, and the FCC. I don't want to be appointed as an informant for the FCC and Big Brother.

Karl Meyer  
Rte. 3  
Cameron, NC

I'll bet you've gotten plenty of feedback on Harry Caul's article in the July POP'COMM. He definitely over-extended his privileges of literary license on that one! As I and countless other longtime SWL fans of 3895 can tell you, he's on his way to seriously undermining POP'COMM's credibility. Nothing convinces me that he did any research at all. To base an article only on a list of unsubstantiated, unresolved complaints and write as if you are an authority on the case is slop-

py, deceitful journalism. The "Alligators" may or may not be guilty of breaking some FCC rules, but they certainly don't appear to be bootleggers or pirates. Unlike some others on frequency, to a man they are very open about who and where they are . . . often giving their phone numbers. Their names and addresses can be checked in any callbook. Hardly a bootleg operation. But the Alligators are not the only people on 3895, they're simply the most numerous and prominent—and organized. Look elsewhere on that frequency for bootleggers and pirates.

Roger W. Pettengill  
Mattawamkeag, ME

*You can take your choice from the three different viewpoints expressed here. Reader Pettengill looks to have tripped over his own logic when he first goes out on a limb to knock author Caul's report by defending a group called "The Alligators" (which were not even named by Caul), and he proceeds to admit that others on the frequency are bootleggers and pirates! Makes little sense.*

*Reader "Karl Meyer" is a long term prolific correspondent under this name and also as "R.D. Carter" of P.O. Box 418, Vass, NC. His letters sometimes contain rather blunt ethnic slurs and one even ended with a "Heil Hitler." Under his "R.D. Carter" persona, he has written to demand that we stop running Alice Brannigan's photo because of an effect it has upon him which I won't describe in detail. He brags that the FBI and Secret Service have a file on him "as thick as a N.Y. phone book under a dozen names." His comments might well be considered with these factors in mind.*

*And just for the record, for all I know, "The Alligators" may well be a legal group. However, they sound like everything that folks used to complain about CB'ers. Biggest bunch of misfits I ever heard on a Ham band, complete with echo chambers. I wasn't impressed. —Editor*

## On The Right Track

In regard to your July issue Mailbag comments about radio clubs in Canada, I can easily add one more to the list—the Canadian International DX Club in Edmonton, Alberta. Keep up the good work. I am sending a subscription request so I can get POP'COMM all the time.

Shawn Axelrod  
Winnipeg, Manitoba

*I deliberately excluded the CIDXC from the July list because I was seriously concerned about the club's inclination to devote a portion of its otherwise excellent news publication to material I felt was deliberately misleading and of such a nature that it could be considered detrimental to the DX'ing hobby. A CIDXC officer has subsequently assured me that this material has been discon-*

*tinued as its author is no longer a regular contributor to the publication. That being the case, I again add the CIDXC to the list of DX clubs I can recommend. A sample copy of the CIDXC publication is \$1 from the club at 6815 12th Avenue, Edmonton, Alberta, Canada T6K-3J6.*

*The exclusion of CIDXC from the July listing brought in 17 comments, 12 of which were annoyed to one extent or another. Four were from persons sufficiently enraged to be classified as profoundly hysterical. These four correspondents were so bent out of shape when I expressed an opinion that differed from their own that they had to invoke numerous four-letter macho words in order to impress upon me the degree of their revulsion. One other correspondent (from Panorama City, California) was so absolutely furious that he said he was promptly writing a hostile letter about me to Monitoring Times! Oh, wow! That's the first time anybody's "told on me" since I put a frog down the neck of some girl's dress. I was in the fourth grade at the time.*

*To be frank, it's just not easy sitting at the rusty Smith-Corona portable using my one-finger hunt-n-peck typing system, knowing that I have the power to cause good folks to cuss and swear or denounce my opinions to Monitoring Times. Just think what havoc I might wreak if I ever sprayed some WD-40 into this typing machine and then figured out how to use it with both hands!—Editor*

## He's Applauding With One Hand!

I have mixed feelings about the opinions expressed by the editor of POP'COMM. Some are well thought out and very intelligent, while others appear to be hastily made, arbitrary, uninformed, and dumb. Maybe if the editor can't come up with intelligent opinions all of the time, then he should sign off in the Opinions Department.

Robert Ramirez  
Scottsdale, AZ

*Win some, lose some! Permit me to speculate that those opinions that reader Ramirez thinks are intelligent are those with which he heartily agrees, while any he doesn't endorse lean toward the dumb end of the scale. Of course, every opinion expressed in our pages invariably brings in letters from those who agree and from those who disagree. But I have lots of opinions, and I've been dispensing them for years without either playing it for the bleachers or worrying about who'll get into a snit. The alternative is to say nothing, do nothing—be nothing! I got started in communications as a youngster, and after almost 40 years at it, I like to delude myself into thinking that I have as much reason or right as anybody else to know what I like and dislike. I also have the*

(Continued on page 71)



# LISTEN FOR LESS



**DISCOUNTS FROM EGE**  
Order Early for Christmas

## SHORTWAVE LISTENING

## SCANNERS

**uniden®**



**R71A** Limited Quantities 599.95  
General Coverage Receiver

FL-44A filter ..... 149.00  
FL-63 CW filter ..... 45.00  
RC-11 Remote Control ..... 55.00  
EX-310 Voice Synth ..... 36.00  
(Accessories installed free when purchased with radio.)

Extended warranty ..... 59.95  
(Includes **all labor** for one year and parts for the first 6 months on an R-71A purchased at EGE.)

## KENWOOD



**R-2000** general coverage ..... Call  
**R-1000** high performance ..... Call  
**R-600** general coverage ..... Call

### SUPER-DUPER SPECIALS ON KENWOOD RECEIVERS THIS MONTH

Extended Warranties available on Kenwood — Please Call

## YAESU



**FRG-8800** Receiver ..... 510.00  
The newest CAT technology

**FRG 9600** Scanner ..... 499.95  
Continuous Coverage  
60 MHz-905 MHz, All-mode

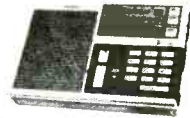

**SONY**  
ICF-2002 Compact ..... 199.95  
ICF-2010 Receiver ..... 279.95  
ICF-7600A Receiver ..... 129.95  
ICF-4910 Receiver ..... 89.95



**PANASONIC**  
RF-3100 Receiver ..... 268.00  
RFB-300 Receiver ..... 194.95



**BEARCAT**  
DX1000 Receiver ..... 399.95

## ANTENNAS

**SONY AN1** active antenna 79.95  
**MFJ 1024** outdoor ..... 113.00  
**MFJ 1020** indoor ..... 75.00

## INTERFACES

**DECODING MORSE & RTTY**  
**AEA SWLText C-64** ..... 83.95  
**AEA CP1** interface ..... 179.95  
**MFJ 1225** read only ..... 65.00  
**Kantronics** Interface II ..... 210.95

We carry a complete collection of teletype frequency guides ..... Call

## SWL BOOKS

Full selection in stock ..... Call

**World Radio-TV Handbook**  
An additional \$2.00 off the new 1985 version when purchased with an SWL Receiver



**Regency®**  
Z60 60-channel ..... 229.00  
Z45 45-channel ..... 195.00  
Z30 30-ch, 6-band ..... 159.95  
Z10 10-ch, 6-band ..... 136.95  
HX1000 30-ch handheld ..... 199.95  
New HX2000 handheld ..... 349.00  
New MX4000 mobile ..... 389.00  
R1060 10-ch, 6-band ..... 99.95  
MX3000 30-ch, 6-band ..... 214.95  
MX5000 25-512 MHz ..... 349.95  
MX7000 25 MHz-1.2GHz ..... 445.00

## Bearcat



20/20 40 ch/aircraft ..... 274.00  
New 100XL Handheld ..... Call  
260 16 ch mobile ..... 248.95  
201 16 ch/aircraft ..... 169.95  
180 8-band, 16 ch ..... 149.00  
210XL ..... 195.95  
300 50 ch/aircraft ..... 341.00

## WE ALSO CARRY

**AMATEUR RADIOS**  
By Kenwood, Yaesu, Icom, Ten-Tec, and Santec

**TOWERS & ANTENNAS**  
By Cushcraft, KLM, Mosley, Hustler, Hy-Gain, Unarco-Rohn, Avanti, Larsen, and more.

**MARINE RADIOS**  
By Icom and Regency Polaris

**COMMERCIAL LAND MOBILE**  
By Yaesu, Regency, and Icom

**ACCESSORIES**  
For all your needs ..... please call

**RADAR DETECTORS**  
Bandit 55 ..... Sale 99.95  
Bandit 95 remote ..... Sale 129.95

**40-CHANNEL CBs**  
PC-33 AM ..... 41.00  
PC-55 AM ..... 59.95  
PC-66 AM ..... 79.95  
PC-77 AM ..... 99.95  
PC-244 mobile SSB/AM ..... 129.95  
Grant SSB/AM ..... 159.95  
Washington base ..... 189.95  
Zach Taylor AM base ..... 129.95

**COBRA CBs** ..... Call  
**MIDLAND CBs** ..... Call  
**WHISTLER** Radar Detectors Call

## ege, inc.

13646 Jefferson Davis Highway  
Woodbridge, Virginia 22191  
Information & Service: (703) 643-1063

Store Hours: MTT: 10 a.m. — 6 p.m.  
WF: 10 a.m. — 8 p.m.  
Sat: 10 a.m. — 4 p.m.

Order Hours: M-F 9 a.m. - 7 p.m.  
Sat 10 a.m. - 4 p.m.

Send 3 22¢ stamps for a flyer.  
Dealer Inquiries Invited



**Terms:** No personal checks accepted. Prices do not include shipping. UPS COD fee: \$2.35 per package. Prices are subject to change without notice or obligation. Products are not sold for evaluation. Authorized returns subject to a 15% restocking and handling fee and credit will be issued for use on your next purchase. EGE supports the manufacturers' warranties. To get a copy of a warranty prior to purchase, call customer service at (703) 643-1063. It will be furnished at no cost.

### Hard to get through on our 800 number?

Call before 10 a.m. or after 5 p.m. ET, or call one of our regular numbers. If you pay for the call and order, we'll credit your order with \$1.

### Ask about our NEW SERVICE DEPARTMENT

In-store repairs on major brands



**For Orders and Quotes Call Toll Free: 800-336-4799**  
Virginia Orders and Quotes Call Toll Free: 800-572-4201



# The Amazing Log Of Radio Marti

***It Took More Than Three Years To Put It On The Air! But Now It's Here!***

BY GERRY L. DEXTER

**“G**ood morning Cuba, you are listening to Radio Marti, on the air today. Now, Radio Marti. Radio Marti . . . for the right of all men to be free and to receive information and disseminate it, to look for truth and hold it high among other people who respect it.”

It was 5:30 a.m. Eastern Daylight Time, the morning of May 20, 1985. Cuban-born Moises Lopez had just read the first words on the first broadcast ever over Radio Marti, the new Voice of America service to Cuba. Charles Wick, Director of the U.S. Information Agency; Gene Pell, Voice of America Director-designate; and Jorge Mas, director of the Radio Marti advisory board were all in the studio as the inaugural broadcast went out over the airwaves. So were reporters and TV news crews, recording for history the start of the new service and the end of a long and bumpy road.

Let's pretend we are at the movies now, and have just witnessed the preceding scene on the silver screen. The picture now diffuses a little, perhaps billowy clouds float onto the scene, or mists roll across the picture, creating a flashback . . .

*June, 1981* — Republican Senator Jesse Helms of North Carolina, Chairman of the Foreign Relations Committee on the Western Hemisphere, introduces legislation which would call for all Voice of America broadcasts to Cuba to bear the designation “Radio Free Cuba.”

*August, 1981* — The Reagan administration, still less than a year old, announces that it is studying a plan which would create a radio station that would broadcast specifically to Cuba. The service, tentatively titled “Radio Broadcasting to Cuba,” would be patterned after Radio Free Europe’s broadcasts to Eastern Europe and Radio Liberty’s to the Soviet Union. Additional funds would be needed to set up such a service and legislation would therefore be required. A separate agency would handle the broadcasts, which would emphasize news items censored in the Cuban press.

*September, 1981* — The administration announces that it intends to go ahead with the special broadcasts to Cuba. The station will be named Radio Marti, after Jose Marti,

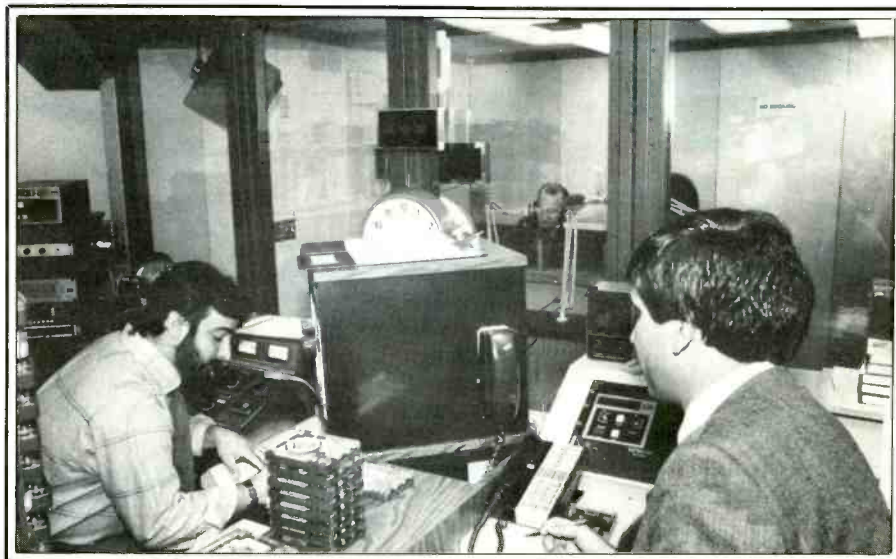

*Radio Marti gets ready to go on the air from its studios in Washington, DC. (Photo by Vincent J. Ricardel, USIA)*

Cuba’s George Washington. An operational budget of up to \$10 million is the cost estimate and the station is expected to be on the air by January, 1982. Studios and transmitters are expected to be located in Florida, although a specific site is not yet chosen. Programs will contain information said to be unavailable to Cubans through their own media and will contain entertainment and commentary. The facility is envisioned as operating during local daytimes only.

The Associated Press quotes an unnamed Cuban diplomat as saying that such a station would be “risky and dangerous.” Other reports note that Cubans already listen quite openly to the Voice of America and one Cuban notes that “Marti is our hero. It is scandalous for Washington to appropriate his name for their propaganda.”

The Cuban magazine *Verde Olivo*, published by the Cuban armed forces, calls the Radio Marti plan “a new provocation” and “another chapter in a 20 year history of economic blockade, threats and criminal aggression against Cuba.”

*October, 1981* — *The Washington Inquirer* quotes Vice President George Bush as saying that “Radio Marti terrifies Castro.”

Florida broadcasters offer their assistance with the Radio Marti plan and point out that they already have facilities in operation that could carry such a program, saving the government from having to build a station.

Editorials and diplomatic and congressional comments fly back and forth. There are fears that the new station might bring more boatloads of refugees from Cuba, that Cuba might bring high power transmitters into play and disrupt the signals of domestic U.S. medium wave stations. Others say you can’t propagandize Castro out of power. Radio Marti’s credibility is called into question, as is its cost effectiveness. In the meantime, it’s announced that the station will probably operate on 1040 kHz.

*November, 1981* — Castro warns that if Radio Marti goes on the air, it will be jammed. Not only that, Cuba will put a number of high power stations on the air as competition. Frank Shakespeare, up for confirmation as head of the Board for International Broadcasting, says the new station would be a “surrogate local radio service.”

*December, 1981* — Cuban delegates to the World Administrative Radio Conference in Rio de Janeiro storm out of a meeting





Here is a wide angle view of Radio Marathon in Washington. This is where the programs are taped and then sent to the transmitting sites in Florida every day. (Photo by Vincent J. Ricardel, USIA)

after the U.S. and other Western Hemisphere nations voted down Cuba's request for changes in its AM station "inventory." U.S. delegates admit plans for proceeding with Radio Marti, a plan the Cuban delegates term an attack on their sovereignty.

**January, 1982**—Radio Marti does not meet its originally hoped-for air date. F. Clifton White, a public relations man from Connecticut and a Republican Party official is named by President Reagan to be chairman of the Radio Marti Board of Directors. Others on the board include William Bourne Bayer of WINZ Radio, Miami; Joseph Coors, president of Coors Brewers; Tirso Del Junco, chairman of the California Republican Party; George Jacobs, former director of engineering for the Board for International Broadcasting; Jorge Mas, president and chief executive officer of Church and Tower, a Miami engineering firm; Richard Scaife, a Pittsburgh publisher; Herbert Schmerts, a public affairs vice president at Mobil Oil; Richard Stone, former senator from Florida; and Charles Z. Wick, Director of USIA. Jorge Mas is also head of the Cuban American National Foundation and was, with his group, an instrumental factor in getting the White House to consider the Radio Marti idea.

Several Democratic congressmen issue a letter opposing the Radio Marti project.

**May, 1982**—Radio station WHO, a clear channel 50 kilowatt station in Des Moines, Iowa, along with other U.S. broadcasters, weigh in against Radio Marti, which is still scheduled to operate on WHO's 1040 frequency. The Des Moines station fears interference from Cuban jamming with a resulting loss of coverage and revenue.

Frequencies of 530 and 1610 kHz are suggested as alternates for Radio Marti. Shortwave is also suggested. The administration is against both, believing that such changes would cause a loss of audience in Cuba.

Four 250-foot antenna towers are erected by the U.S. Navy at Saddlebunch Key, Florida. This occurs in advance of congressional approval of Radio Marti and provokes an angry response from Timothy Wirth, Democrat of Colorado, who is chairman of the House subcommittee on telecommunications. He calls the construction of the towers illegal. Lt. Commander Mark Neuhart, public affairs officer for the U.S. Caribbean Forces, tells the *Miami Herald* that the towers are for Radio Marti but won't be used before congressional approval is given. The towers are never used for Radio Marti and their original purpose, if not for Marti, remains unexplained.

**August 26-30, 1982**—Cuba gives a dramatic warning demonstration of what might happen if Radio Marti goes on the air. The evening hours on at least two of these dates see high power Cuban transmitters carrying Voice of Cuba broadcasts in English. Frequencies include 570, 600, 650, 670, 1040, 1160, and 1380. U.S. broadcasters are up in arms as their listeners complain of interference with reception. The National Association of Broadcasters takes a stand opposing Radio Marti.

**July, 1983**—The Radio Marti bill moves out of House committee hearings. The bill specifies that Radio Marti must use the VOA medium wave frequency (1180 kHz) and sets up a \$5 million compensation fund for U.S. broadcasters who may suffer from jamming interference.

**August, 1983**—After hours of argument and proposed amendments, the U.S. House of Representatives approves the Radio Broadcasting To Cuba Act and sends it to the Senate. Amendments which would have called for the station to operate on shortwave instead of medium wave or would have limited the station to operation on only one frequency are defeated. One congressman calls the whole thing "a game of chicken with Castro." The Associated

Press quotes Representative Henry B. Gonzales as saying "we're headed straight for an electronic or a radio Bay of Pigs." Deputy Cuban Foreign Minister Ricardo Alarcon says Cuba will "definitely" respond with increased transmissions blocking U.S. commercial stations. The Cubans believe that if U.S. stations are hurt in the pocketbook, they have enough influence to silence Radio Marti.

Studios and headquarters for Radio Marti will be in Washington, DC. Programming will also include baseball and soap operas. A new January target date is set.

**September 9, 1983**—The Senate Foreign Relations subcommittee approves funding for Radio Marti, defeating amendments which would have compensated U.S. broadcasters for interference from Cuban jamming.

**October 4, 1983**—Public Law 98-111 "to provide for the broadcasting of accurate information to the people of Cuba, and for other purposes" is approved by Congress. The Broadcasting To Cuba Act specifies the programs are to be part of the Voice of America and to run 14 hours per day. A budget of \$14 million is approved for fiscal 1984, \$11 million for fiscal 1985. VOA medium wave facilities at Marathon, Florida (1180 kHz) as well as the special U.S. Navy installation in the Keys will be used. President Reagan signs the bill into law and the Cubans say they will respond "in every way possible and with decision, energy, militancy and unity."

Recruitment efforts get underway to hire a staff for the new service.

**December, 1983**—William March, once employed by Radio Free Europe and once chief of Voice of America news, is appointed head of an organizational task force charged with getting Radio Marti on the air. He is assisted by Seth Corpsey, VOA Policy Director. Neither is expected to remain with Radio Marti once it is operational. The two men visit Miami looking for Cuban exiles who might be suitable as Radio Marti employees. Advertising for positions with the station is expected to begin shortly.

VOA Director Kenneth Tomlinson says that an opening date for Radio Marti will be announced "next month." Some sources believe it will not begin broadcasting until the spring of 1984.

**January 1, 1984**—"Spring" it is. The January 1 target date is not met, but the VOA includes features on the 25th anniversary of the Cuban revolution in its programming. Marsh, a few days earlier, noted that the station didn't yet have the people it needed and would rather delay than go on half prepared.

**Mid-January, 1984**—Speculation exists in certain hobby listening circles that the Navy installation in Florida will be used to broadcast Marti on 530 kiloHertz. The Voice of America denies this.

**January 18, 1984**—The U.S. Advisory Committee on Public Diplomacy issues a warning that making Radio Marti part of the



Voice of America could damage the VOA's credibility.

May 20, 1984—Another target date for Radio Marti to begin broadcasts is missed.

May 23, 1984—*The New York Times* publishes a story which takes a look at the Cubans' views of Radio Marti. Most seem unimpressed or disinterested or claim to know nothing about it. Others note that they listen regularly to U.S. domestic stations and networks. Many expect Radio Marti to broadcast "lies." The story notes that Cuba is considering jamming Radio Marti when it goes on the air.

November, 1984—Sign on has been postponed again from a fall target date to late December. Employees are still being sought. Officials note that delays are due in large part to the time taken by security clearances for prospective personnel. Radio Marti recruiters Humberto Medrano, deputy director of the station, Bruce Boyd, personnel director, and Jorge Riopedre, news director, interview people at the offices of Union Radio in Miami. Other talent hunts have taken them to Los Angeles, New York, and Puerto Rico.

Rogene Waite, public information specialist at the VOA in Washington, says staffing and organizational problems have delayed the start of the station and adds that no one thought it would take this long to get the station "off the ground." Only a third of an approximate 180 staff members have been hired.

December, 1984—49-year-old Paul Drew, and experienced producer and former Vice President of RKO Radio, is named as Radio Marti Director. Drew notes that the station "offers the challenge of building a great radio station and doing something important for the people of Cuba and my country." Drew had been serving as a Radio Marti consultant since October. He is the second choice for the position. Earlier, Miami radio newsman Emilio Milian (who has his legs blown off in a 1970 terrorist bombing) was selected but failed to reach an agreement with the VOA.

January, 1985—Senator Paula Hawkins, Republican of Florida and a strong backer of Radio Marti, says the Reagan Administration has assured her the station will begin broadcasting on January 28, Jose Marti's birthdate.

Paul Drew suddenly resigns as Radio Marti Director. The VOA gives the reason as a "personal emergency." Newsmen cannot reach Drew for his immediate comment. The *Miami Herald* quotes anonymous sources as saying the resignation was the result of a power struggle over personnel matters. Someone from within the Radio Marti service tells *Broadcasting Magazine* that USIA Director Charles Wick asked for the resignation. Kenneth R. Giddens, owner of WKRG in Mobile, who served an eight year stint as VOA Director, is named acting director of Radio Marti.

Drew later says he came to the realization that it wasn't possible to fulfill his commit-

**United States  
Information  
Agency**

Washington, D.C. 20547

Voice of America



June 12, 1985

Dear Mr. Dexter:

We are pleased to confirm your reception of broadcasts of the Voice of America - Radio Marti Program.

We hope that this confirmation letter will be satisfactory until our QSL cards are printed. You will receive a QSL card when they become available.

The Radio Marti Program broadcasts on medium wave frequency 1180 kHz from 0930 - 1700 and 2030 - 0300 (UTC) (0530 a.m. - 1330 p.m. and 1630 - 2300 Eastern Daylight Time) with 50,000 watts power. Currently, the Radio Marti Program also broadcasts on shortwave frequencies as noted below:

TIME (UTC)	EASTERN TIME	FREQUENCY	POWER (Watts)
0930-1200	5:30 am - 8:00 pm	6075 kHz	250,000
1200-1400	8:00 am -10:00 am	9570 kHz	250,000
1400-1730	10:00am - 1:30 pm	11815 kHz	500,000
2030-2300	4:30pm - 7:00 pm	11960 kHz	500,000
2300-0300	7:00pm -11:00 pm	9660 kHz	250,000

Thank you for your interest in the Radio Marti Program. We hope you will continue to enjoy our programming.

Sincerely,

Thomas Warden  
Deputy Chief, Technical Operations  
Radio Marti Program

Gerry Dexter's QSL letter from Marathon.

ment; he lacked sufficient confidence in his ability to provide a quality service. Drew, according to some reports, had decided that the Radio Marti news department hierarchy could not do the job and demanded that either they be dismissed or he would resign.

January 28, 1985—The birthday of Jose Marti passes without Radio Marti broadcasts. Hawkins is upset and issues a statement calling the affair "one of the worst cases of bureaucratic bungling I've seen in the four years I've been a U.S. senator. Castro not only runs our immigration policy but our radio policy as well."

The Voice of America Spanish services airs a special program about Jose Marti, which some shortwave listeners momentarily believe is the station itself, on the air at last.

February, 1985—The U.S. Advisory Commission on Public Diplomacy recommends that Radio Marti operate as a separate entity under the Board for International Broadcasting, as is the case with Radio Free Europe/Radio Liberty.

Reports say the Radio Marti staff is worried that the service will never get on the air; that it will be used instead as a bargaining chip in negotiations with Cuba. There is speculation that perhaps VOA higher-ups are deliberately slowing progress.

February/March, 1985—Whether in an-

tipication of Radio Marti or for other purposes, Cuban broadcasting is undergoing changes. A number of high echelon officials are dismissed. Western movies show up on Cuban television. American pop and rock—including the USA For Africa song "We Are The World," is on the radio. Radio Havana Cuba's international shortwave broadcasts seem to have a less heavy tone.

April, 1985—VOA public relations specialist Rogene Waite says Radio Marti may begin "next month." Officials continue to blame delays in personnel security checks and the task of putting together a 14-hour-a-day format. Some 120 employees are on the staff, including 20 in the research department. Sunday Catholic mass will be part of the schedule.

May 20, 1985—Radio Marti is on the air at long last. According to Waite, foreign cables and news reports indicate that the station is being heard clearly in Cuba, although acting program director Richard Araujo, while noting that the message was loud and clear, also detected a "buzzing sound" during part of the broadcasts. It seems that Cuba is jamming the 1180 kHz transmitter.

Almost from the first moments of Marti's start, DX'ers in Florida and elsewhere flash word that Radio Marti is operating on shortwave as well, a quite unexpected event.



Waite says replies to early questions about shortwave use were answered with a statement to the effect that the "legislation calls for the use of 1180." She believes shortwave will continue to be used for Radio Marti "for the immediate future" and does not view its use as part of an initial "splash" intended to gain extra attention.

The first day's programs, according to a VOA press release, consisted of news, entertainment, sports, correspondent's reports from around the world, a comedy show, and a soap opera. Cuban scholar Carlos Alberto Montaner, who lives in Madrid, delivered a commentary, and a VOA editorial entitled "Freedom In The Air" was also aired.

Studios of Radio Marti are at 6th and "D" Streets NW in Washington. The programs are fed by satellite (with a microwave/landline backup) to Marathon, Florida. The shortwave broadcasts come from the VOA's 250/500 kilowatt transmitter complex in Greenville, North Carolina.

Additional Radio Marti programming will include interviews, science updates, and religion. News bureaus are being established in Miami and New York, with stringers located in Europe, Central and South America, the Caribbean, and Africa.

Although 187 positions have been authorized, Radio Marti signed on with a staff of 126. A nine member advisory board reviews the station's activities and reports to the President, the Director of the USIA and the Director of the VOA. The broadcasts must be in accordance "with all Voice of America standards to insure the broadcast of programs which are objective, accurate, balanced and which present a variety of views."

Castro responds before Radio Marti's first day is done. He suspends a U.S.-Cuba immigration agreement that had been signed less than six months previously and he halts travel between the U.S. and Cuba. Diplomatic sources, quoted in some news stories, say Castro is preparing to launch a special propaganda station of his own. It will be called "Radio Free Lincoln."

May 29, 1985—UN Secretary General Javier Perez de Cuellar has discussions with Castro which reportedly include a Cuban request that the UN Secretary General use his influence to get the United States to halt the Marti broadcasts.

And that is the end of our feature presentation "The Log of Radio Marti." It took three and a half years to put Radio Marti on the air—years filled with threats, dissenting voices, and no little media coverage reporting on the endless delays and problems that continued to confront the station.

Only time will tell us whether Radio Marti can or will accomplish the job that it has been assigned. We will have to wait and see if Cuba has other answering moves up its sleeve. If so, then a year or two from now, we may be headed for our local theaters to see "Radio Marti II." **PC**

Note: Some of the dates noted in this article are approximate.

## Receiving Antennas

### Butternut Introduces SC-3000 A Scanner Antenna for the "Pros"!

Butternut's patented "trombone" phasing sections increase capture area and let you pull in the weak signals that aren't even there on conventional scanner antennas.

- Covers 30-512 MHz scanner ranges
- Omnidirectional coverage area
- Receive gain
  - UHF Up to 7 dB
  - VHF Up to 3 dB
  - Low Band-Unity gain
- Height 11 ft.

For the SWL . . .

Tune in the weak ones. Butternut's exclusive inductive stub-tuned dipole requires no heavy lossy traps. Specifically engineered for maximum signal to noise on the popular 13, 16, 19, 25, 31 and 49 meter foreign broadcast bands. Covers 2-30 MHz. Includes 50 ft. of feedline. Maximum overall length 73 ft.

Dealer inquiries invited



**BUTTERNUT ELECTRONICS CO.**

405 E. Market Street • Lockhart, Texas 78644

Please send all reader inquiries directly.



**ICOM R71A**  
100KHz - 30MHz  
CALL FOR PRICE



**ICOM R7000**  
25MHz - 1.3GHz Plus  
All Mode  
Top of the Line Scanner  
CALL FOR PRICE



**FRG 8800**  
150KHz - 30MHz  
CALL FOR PRICE



**FRG 9600**  
All Mode Scanning Receiver  
60-905MHz  
CALL NOW  
FOR SALE PRICE



**THE HAM STATION**  
P.O. Box 4405  
220 N. Fulton Ave.  
Evansville, IN 47710

Orders 1-800-523-7731  
Indiana (812) 422-0231  
Info & Ser (812) 422-0252

Mon. - Fri. 9 AM - 6 PM Sat. 9 AM - 3 PM  
MasterCard, Visa, American Express & COD's Welcome





# Spy Number Transmissions

*Spy Or “?” The Mystery Continues*

BY ROBERT M. DYQUETTA

**F**or roughly the past two decades, short-wave monitors have been encountering a class of radio transmissions known collectively as “the numbers.” Today, these transmissions are so common and prevalent that

one could literally set a watch by their predictable activity. Yet in all this time, the true nature and purpose of the number transmissions has remained an enigma.

Previous *POP’COMM* articles presented

the baseline parameters while examining a host of possible motives for these transmissions. The one that is most appealing and widely championed is that of the spy/intelligence operation concept. This aspect has been touched upon before and here we will further examine it, for it is a fundamental question, which when addressed, does provide a baseline for examining and understanding the number transmissions themselves.

The question we’re pondering is this: “Are the number transmissions of the spy gender, or are they something other than a covert intelligence operation?”

We now know that the U.S. government regards the numbers as legitimate radio transmissions. Legitimate yes, but operating within a dark abyss of an ITU loophole.

All legit radio transmitters must be registered with the International Telecommunications Union, otherwise their operations fall into the category of being illegal (clandestine). But a loophole is there to accommodate stations and activities, conducted by governments, which in some manner involve aspects of their national security. Basically these activities include certain military and virtually all diplomatic and intelligence operations.

Confidentiality of such activities is paramount to a nation’s security and, as such, all signatory members of the ITU have this loophole option at their disposal. It is, in effect, a *carte blanche* mandate that permits an entire strata of radio operations to be conducted without benefit of identification nor registration. Of course it is left up to each nation to determine what radio activities fall within the parameters of their national security.

Therefore it is not at all surprising that under these conditions (which is some applicable form of the national security doctrine), those involved would not be at liberty to discuss nor divulge parameters of these transmissions, except with those who have authorization to receive such data. Hence national security equates to secrecy. Carried forward, this would also include commenting on similar transmissions that are conducted by other nations.

In North America, three major classes of number transmissions can be regularly monitored. Due to the efforts of certain number investigators, we now know the transmitter locations for these major types. This was covered in a previous article, but the end result is that the USA and two communist bloc nations (probably acting as intermediaries for the USSR) are the sources for one of each of the major number types.

The lack of any U.S. government agency to publicly comment on the parameters of the number transmissions places said radio activity within the national security envelope. One of these aspects includes intelligence, both in the gathering of data and the methods employed to secure such information. As such, because of the peculiar nature of the number transmissions, they lend themselves to the perception that they are indeed of the intelligence (spy) gender. Fol-



lowing this logic, we find as representatives of these transmissions nations whose political social ideology is diametrically opposite. Hence we have what appears to be intelligence and/or counterintelligence operations between ideological antagonists.

On the other side of the coin, this assumption comes up against some stiff opposition. Even though the three major number types have transmission characteristics that clearly denote individuality, the overall parameters are too similar to be totally and coincidentally independent. As such, in order for this spy gender concept to have validity, one must accept as fact that opposing intelligence organizations (by sheer coincidence), devised and placed into operation a radio medium activity having so many similarities with its opposite counterpart. It is as if these antagonists have struck a bargain to conduct such radio mode endeavors by adhering to a mutual agreement for said operations. The fate of this world is literally in the hand of two global powers. One is striving to maintain its social ideology, while the other intends to impress theirs on everyone it can. This is high stakes poker, yet we are to believe that they would go about it (at least from the number transmission aspect) via a mutual game plan.

The entire mystique surrounding the number transmissions oozes intrigue. In fact, such activity seemingly comes right out of the pages of a good spy novel. Thirty to forty years ago, this type of radio activity would fit perfectly into the spy mold, but not today. The USA and USSR have, at their disposal, the most modern and sophisticated electronic technology now imaginable. Intelligence operations are a critically vital part of a nation's national security doctrine, and it is inconceivable that any portion of this effort would be carried out in what amounts to kindergarten level techniques.

We can examine this logic and obtain a broader understanding of it by looking at the radio activities of its kissing cousin.

All major governments interface through diplomatic channels, and part of this discourse is carried out via the radio medium. Who among you have monitored these government-to-government radio exchanges? And if you have, were they understandable? Just like intelligence, diplomacy is part and parcel of a nation's national security. As such, when it is conducted via radio, they employ esoteric methods to prevent anyone but those involved from eavesdropping, much less deciphering the exchange. The most obvious example of this is the Washington/Moscow hotline.

The major powers devote enormous amounts of manpower, electronics, and finances to insure that this and other aspects are carried out in utmost secrecy. And, by the way, a considerable effort is devoted to SIGINT—signals intelligence; eavesdropping and deciphering communications from the opposite camp.

The hallmark of today's diplo/intel radio activities is to conduct them as obscurely as possible, making any casual interception

only a remote possibility. Burst transmissions, sub-carrier mode, frequency hopping, voice and data inversion, narrow band multiplexing, combined with secure crypto methods, is the name of the game today. Yet here we have the number transmissions. Anyone can monitor them, and with little time and effort, you can assemble an hour by hour, day by day operational schedule. The numbers project an aura of what we'd expect a spy transmission to be doing, but considering the technological and political realities, what they are doing is absurd.

Coming to the defense is the idea that these transmissions are to agents in the field. Hence simplified methods must be employed, for the agent can ill afford to be saddled with a room full of electronic gear, nor confronted with convoluted deciphering techniques. Even this isn't a reality. In the enclaves of the military, diplomatic and intelligence community are radio receivers that we would class as dream machines. Small and compact, they are fully capable of interfacing with any of the more esoteric transmission mediums with microprocessor circuitry allowing for on-line decipherment. In some instances, they can receive transmissions direct from satellite downlinks. Sounds like fiction, but based on fact. Every substantial advancement in radio equipment first appeared in government usage. They had their origins and applications with government agencies before the technology filtered down to the commercial market. If you believe the latest crop of SWL receivers are fantastic, just try to imagine what certain agencies are now using today.

This is the technology of the 1980's, and even though the espionage business utilizes methods, basically the same practiced for the last two or more thousand years, the electronic aspect is considerably more sophisticated.

Undoubtedly simple CW and voice mediums are still employed, but to assume it would be applied to a major operation by both sides strains credibility to its limits. But this is just what some number buffs believe. The number transmissions use such a primitive and outmoded technique that no one would believe intelligence agencies would resort to it. Hence, use reverse logic and use it. On face value it is so outlandish that it is possible. But by observing the scope and magnitude of today's number transmissions, they are in no way to be considered a minor endeavor. They are a major operation. As I stated, since intelligence activities are so vital to a nation's security, no aspect of it would be conducted in such an open forum as the numbers now do.

Some number buffs contend an explanation could be that these are actually training exercises for fledglings who are to go into the intelligence field. Irrespective of the absurdity of publically broadcasting an aspect of intelligence training, the current technological reality is also there. It would be akin to training someone to master a sailplane, then turning them loose to pilot a modern jet aircraft. Granted to train, you start with the

basics and then work your way up. But at no time would you publically expose any aspect of intelligence oriented training exercises.

There are two aspects of the number transmissions that bestow on them a level of high importance. One is the message text. To date no one has successfully deciphered any message. If these texts are conventionally worded and not encoded item references, then the cipher employed is quite sophisticated. The only one filling the requirements is the random numerical key variety. Without knowing the RNK sequence, it is impossible to decipher, yet with it, it is simple, even with paper and pencil methods. Yet one doesn't have to have arcane knowledge to construct a long RNK sequence. A telephone directory from any major city will provide one with hundreds of thousands of random numerics (utilizing only the last 4 digits). Those with computer expertise can program a computer to crank out voluminous amounts of random numbers, much in the same basic manner the government generates RNK sequences. In essence, the RNK is simple to assemble and use, but diabolically difficult to decipher.

On the other side of the coin, possibly no one has been able to decipher any number transmission simply because they are meaningless assemblages of random numerics. Here logic can be made to run backwards. Many buffs assume these transmissions are encoded messages. Assume this, and therefore the numerical texts must be conveying something genuine. Ergo, you get out the cryptographic books/load computer program to figure out a definitive pattern that will lead you to a proper decipherment. This is difficult enough to do when faced with a genuine enciphered text, but just imagine how frustrating it can be when the text is actually gibberish and you're not aware of that reality.

Of course the question is why? Why devote two decades of time and an obviously ever increasing financial outlay merely to transmit meaningless garbage over the airwaves. This wouldn't fool the opposition, more so since the opposition, via parameter similarities, is doing the same thing. To believe that those involved are doing so just to pull a Halloween prank on radio monitors is likewise blatantly absurd. So it must be acknowledged that the number transmissions have a definite purpose, therefore importance. This is strongly supported by the total security blanket the government has draped over these transmissions. There is no justification for this, unless the numbers are in some way involved with national security.

This means politics and therefore bureaucracy. The word here is power, and those having the power can use it or abuse it in accordance with what they believe is the best course of action. In many instances the average citizen is unaware of how this power is applied, or how it can affect them. We leave this in the hands of our elected representatives and the professionals, hoping that they will do their best for us. Power does generate a certain degree of importance and

in varying respects, reduces us to children who should only follow and obey the dictates of their wise old father. This is most apparent in the areas of our national security. Diplomatic negotiations are conducted in secret, be they involved with arms reductions or merely grain purchases. Of course all intelligence matters are kept from public scrutiny, as well as from other parts of the government not associated with said activities. There are justified instances when the people do have the right to know. Military secrets, diplomatic and intelligence activities are prime examples, for if we knew all, so would our potential enemy. Those in power formulate directives, which those under them carry out. This is a positive trait, for it enables our complex and convoluted government to pursue an orderly function, both on an internal as well as external level. But power can corrupt, and its directives can be misinterpreted.

With this all has to do with the number transmissions is a further application of the bureaucratic power rationale. When the U.S. numbers started, this project undoubtedly received a rubber stamp marked "top secret." That classification remains, so those in the power structure see nothing but this indicator. There may be justified reasons for this, but it prevents us from getting any facts. The silence it generates forces us to use our own imagination as to the purpose and motivation behind it all. This follows the old adage that anything kept hidden from us

can't be good. This serves to cast number transmissions in the aura of being sinister, and the reluctance of our government to officially comment on them likewise puts their motivations into the ranks of dark foreboding.

We are in an era when many Americans view their own government with less than respectful glances. Its motivations are suspect and our faith and trust are severely strained. It would be sad that this conception among some of the number buffs was simply the result of a directive now out of touch with reality, being blindly perpetuated by the bureaucratic power rationale.

Even though we are exploring the "spy versus something else" theme, it would be advantageous to examine the early years of the number transmissions.

Exactly when the number transmissions began is lost in the veils of time. Military, diplo/intel uses of numerically coded messages date back thousands of years, and would have fit in quite nicely and naturally when the radio communications medium developed.

During World War II, throughout the Americas, number transmissions were fairly common. These were in the form of weather observations, transmitted in either voice or CW, utilizing a 5-digit format (most often a 3/2 delivery). This evolved into the international five figure metro format. In this, all meteorological data can be broken down into numerical equivalents and transmitted in an item for item reference manner. This metro and other obviously coded government numerical traffic continued after the war. As such, scant attention was paid to them by that era's utility monitors.

Sometime in the very late 1950's or early 1960's, the SS/YL 5-digit transmissions made their radio debut. For lack of hard copy logging data, this time frame is based on the recollections of some of that era's utility monitors. Exactly when the SS/YL 4-digit and the GG/YLs commenced likewise cannot be pinned down, but by the mid-1960's, all three were known to be quite active.

The spy gender proponents can make a valid observation that the SS/YL 5-digits appeared around the time that Fidel Castro rose to power in Cuba. In this light, the 4-digit American version could have been our answer to the Cuban transmissions. Although there is no proof, there is reason to suspect that the U.S. numbers first began operations out of Florida or the Keys, later to be moved to the Remington, Virginia site. Likewise they may have started as an English language version, then later adding a Spanish YL. Today the Spanish YL is the most prevalent of the two that originate from the Remington site.

Down through the years the U.S. number transmissions existed during various administrations, and as such, their activities continued unabated, irregardless if the administration in power was Republican or Democrat, with hawkish, dove or middle of the road philosophies.

From 1960 through the mid-1970's, monitoring data on the number transmissions is very fragmentary. It is unknown if the number activities were on the same extensive and scheduled existence, as they are today. We do know that by 1975, they were practicing an extensive operation that adhered to a regular schedule of day, time, and frequency. This didn't occur overnight, so we can postulate that such was true from probably the mid-1960's onward.

The somewhat surprising aspect was that, until the mid-1970's, very few utility oriented monitors were regularly encountering them. Radio hobby club bulletins and other media radio publications of that era bear this out. But it also must be acknowledged that utility monitoring was basically an avocation for a select minority, and therefore its coverage was small. Hand in hand was that accurate and comprehensive utility data that is so prevalent today, yet was virtually nil ten to fifteen years ago.

By 1975 certain individuals mounted investigations into the number transmissions, confirming what earlier monitors suspected—that a very extensive and enigmatic radio operation was in progress. A combination of data swapping, publishing of observations, a large increase in the utility ranks, expanded hobby club utility coverage and utility data publications, all served to spotlight the number transmissions to the SWLing community.

Today the numbers are a paradoxical mystery. Their radio medium activities are compromised, yet they continue on, just as they have, from their misty beginnings back two decades ago. Their continued operation amply proves that partisan politics had absolutely no effect on them. Likewise, even though their activities are well known within the utility monitoring fraternity, seemingly oblivious to this, they continue on and on.

If the number transmissions were developed independently to serve the interests of a particular government (such as in intelligence operations), then we should see distinctly different radio operations. We don't. Instead one must accept as fact that very similar radio activities came about by pure coincidence, originating within the ranks of both a democratic and communistic system.

Each number transmission type has its own distinctive characteristics, but the overall parameters are too similar to be independent. It is sufficient to state that there is no rationale for this overall similarity, unless these transmissions are aspects of a single entity.

Some number buffs are content to uncover frequencies and log day/times pertaining to each number type. But once one gets beyond this monitoring game pastime and brushes away the wonderment of the spy mystique, you find a somewhat odd reality. With only minor modifications, a 4-digit transmission can be a 5-digit transmission and vice versa. This is easy to conceptualize if the texts are actually worded statements using an RNK type cipher technique. Once

## SPACE SATELLITE HANDBOOK 1986

Up-to-the-minute current listing of all payloads, platforms, rockets and debris in orbit. This annual giant encyclopedia lists 5,612 manmade objects in orbit around Earth, Moon, Sun. Some are still up there from 1958! Data from NASA, NORAD, Smithsonian. Lists common name of satellite, international number, origin country, launch date, period, inclination, apogee, perigee, radio frequency. Handy 80-page paperback book. **\$10.00**

### Quick-N-Easy Electronics Projects

40 electronics projects, new practical build 'em tonite fun gadgets, book. 96 pages. **\$7.95**

### Easy-To-Build Electronics Projects

40 electronics projects, new different state-of-art high technology, book. 96 pages. **\$7.95**

Add \$1 shipping per book. Send cash, check, money order, VISA or Mastercard. Card users include number, expiration. Customers outside USA remit US dollars and \$2 shipping per book.

**ARCsoft Publishers**  
Post Office Box 132SM  
Woodsboro, MD 21798



enciphered, the message is nothing more than an unbroken series of numerics. These can be arranged into any grouping, with three to six being most often used.

Grouping serves both as a copying aid (less errors are made when the numerical text is grouped, rather than transmitted in one continuous unbroken delivery), and as an overall numeric tally. All of the major number transmissions include a group count in its sign-on preamble. Hence if this were a 5-digit transmission with a 20 group count, you must end up with 100 numbers, equally divided into twenty 5-digit groups. As such, the specific use of 4 or 5 digit groupings is probably nothing more than another distinctive characteristic of a particular number type. If an RNK is utilized and the text is a worded statement and not a numerical item for item reference, them from a deciphering standpoint, how the enciphered text is grouped out is of no importance at all.

If these were independent intelligence operations, then the last thing you'd want to do is utilize the same baseline parameters as your opposition. Granted, initially it would serve to confound and confuse, but after two decades of said transmissions, no one would be fooling anybody.

But if of the spy gender, then because of the prolific and continual nature of these transmissions, one would think that a counter operation would be mandatory—though not an operation to mimic and therefore cause confusion. Observe how the Soviet Union deliberately jams SWBC transmissions from the West. So why haven't the number transmissions been jammed? What interference there is, is the fault of those transmitting the numbers. Often there is radio activity on the frequency prior to their coming up. So it's the number transmission that is the QRM culprit, and not the other way around. The SS/YL 5-digit is very prone to do this, seemingly oblivious to the fact that someone else is occupying the frequency when they start their run. As this has occurred quite often, it does suggest that the transmissions are in a total automatic mode (frequency/time wise) and simply go on the air, per preprogrammed schedule. This then could lead one to suspect that it may not matter if the number transmission is receivable or not.

But if the numbers are a spy/intel operation, they would constitute a definite threat. If true, by now some sort of (covert) operation should have been conducted to neutralize the transmitter. This does not mean a commando style raid. Electrical power disruption, internal sabotage and other sly methods could work just as well with far less dramatics than blowing up the facility with satchel charges, mortars, or man portable rockets. But let's face it. If these are independent intel operations, both sides have done absolutely nothing to silence each other's transmitter.

Let us look at the transmitter site for the SS/YL 4-digits that originate near Remington, Virginia. The location is most bizarre, to

say the least. I ask you spy gender proponents to picture this site. Remote, secure, and well guarded would probably be your guess. Well hold on to your socks! The transmitter building/antenna complex is within easy view, and is just several hundred yards from a local county road, with only a chain link fence blocking access from the roadway. Obviously there are hidden security measures, but if this is a spy/intel transmitter site, it is very vulnerable. The NCS facility (which this site sits on) is a sprawling one, and even a bureaucrat would have the common sense to place the transmitter deep within the facility, unobservable and unapproachable by any civilian. Instead, it is just as gaudy as its number transmissions—out in the open for anyone to hear or see. All of this seemingly indicates that the number transmissions are not involved in a spy/intel game.

The number transmissions are most certainly government to government, via one or more of its agencies. On what level and for what purpose remains an enigma, yet it can be surmised that due to decades of continual operation, it is for their mutual benefit. Number transmissions are intertwined with politics, just as much as diplomacy and intelligence share the same pair of pants. By and large, all share the same bed, and that is why the numbers cannot be isolated from its companions.

The only people who have the real answers are those directly involved with the number transmissions. Realistically it would be a futile effort to ask them to divulge the truth, for wrapped as they are in the national security ethic, this seems doomed to failure. Yet one cannot help but ponder this mystery.

From a radio medium aspect, the number transmissions are totally compromised, yet they continue on. No U.S. government agency has given any official and definitive explanation for this radio activity. It is just the omnipotence of power and the bureaucratic

enigmatic rationale that prevents the truth from becoming known? Or are these transmissions involved in something so sinister that if the truth became public knowledge, would cause a nationwide outcry of condemnation? I shudder to think that the latter statement is the reason. I'd rather believe that the silence and security is a blind adherence to directives, which in this case, may now be out of touch with reality.

If the numbers are, after all, an intel operation, then we are not foolish enough to want to know its intimate details. But are the numbers intelligence oriented, or are they something else that can be officially commented on, even if only in rudimentary baseline terms?

We number investigators want to know, even if such revelations are merely a generalized explanation. But if no official comment is possible, then we likewise want a basic understanding of what we can't be allowed to know.

As of this date, the government remains mute on either option. It is quite obvious that the government would like to see interest in these transmissions cease. But the only way this will come about is for the government to issue some sort of official statement on this radio operation. Failing to do so only perpetuates the mystery, and with any mystery, it presents a challenge to solve it.

It may come as a surprise, but many active number investigators want out of this quagmire. Too much time, effort, and frustration exacts its toll. We'd all like to channel our monitoring efforts into other avenues of the SWLing field, but even though we can turn our face from it for a while, the mystery lures us back.

We can only hope that those responsible for the number transmissions will review the directives and ascertain if some sort of official statement can be made. If this can be accomplished, then let it be done, so we can all go about our individual business.

## BUGGED???

Find hidden radio transmitters (bugs) in your home, office or car. The TD-17 is designed to locate the most common type of electronic bug - the miniaturized radio transmitter - which can be planted by anyone, almost anywhere.

The TD-17 warns of the presence of nearby RF transmitters, within the frequency range of 1 MHz to 1,000 MHz, when the RF Alert LED turns on. The flashing Range LED and audio tone give an indication of the distance to the bug. The Sensitivity control, used in conjunction with the two LEDs, helps you quickly zero in on hidden bugs.

The hand-held TD-17 weighs less than 7 oz. and is housed in a high-impact plastic case. Furnished complete with battery, antenna, instruction manual and one year Limited Warranty. Save \$100 to \$200 and order at our factory direct price of only \$98. VISA and MASTER-CARD accepted. Satisfaction guaranteed or your money back. **FREE literature.**



**CAPRI ELECTRONICS**  
Route 1G  
Canon, GA 30520  
(404) 376-3712

# Inside The CIA's Secret Radio Paradise: Part I

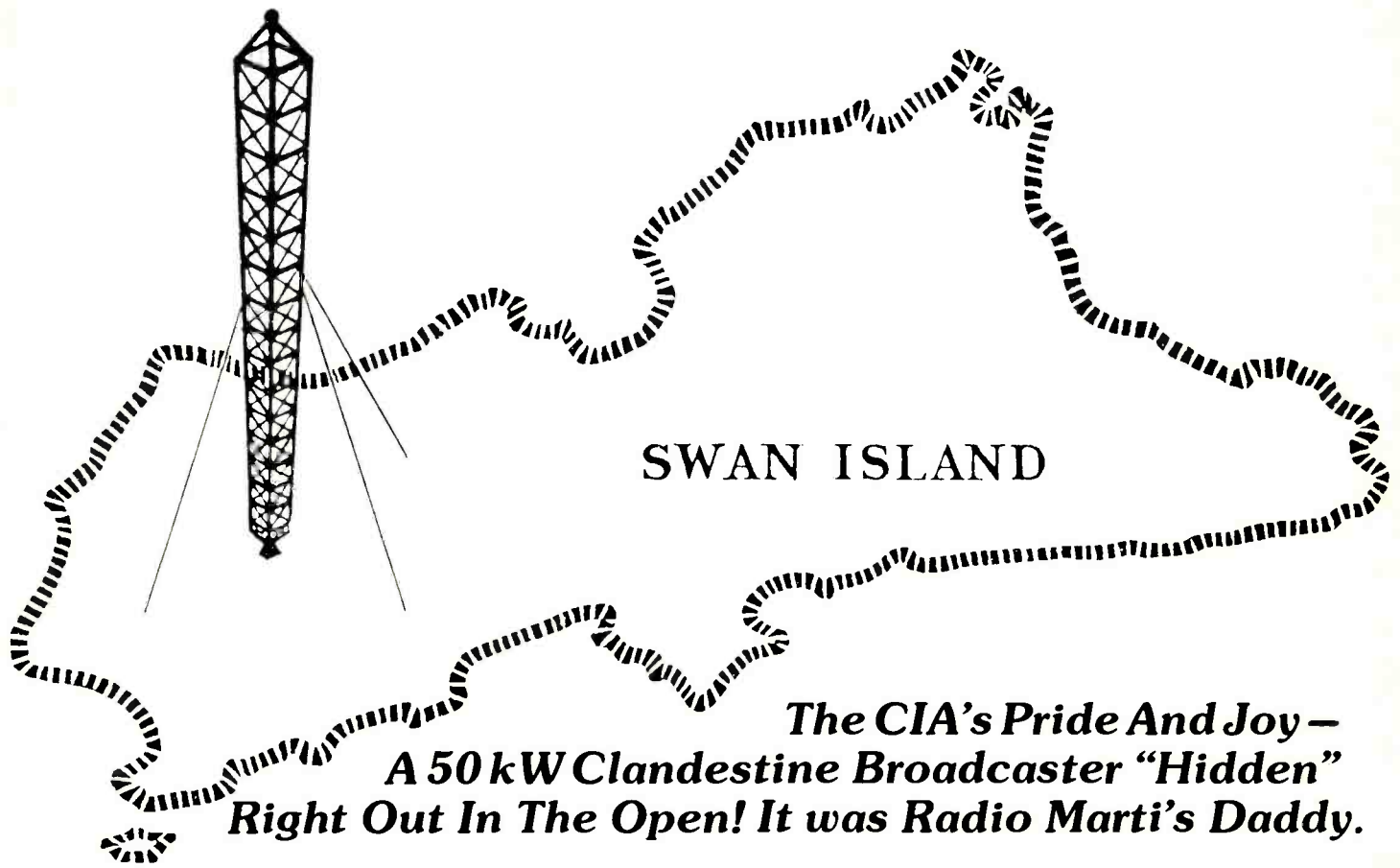

BY TOM KNEITEL, K2AES, EDITOR

**I**t was the Spring of 1960. Fidel Castro had not only taken control of Cuba, he had made it quite clear that he wasn't a friend of the United States. Castro was making plans to grab the lucrative American industries in Cuba even though they had not only brought a considerable amount of money into Cuba for years, they had supported the revolution that put Castro in power in February of 1959.

Because of the tense Cuban-American situation and the fear of further weakening inter-American diplomatic esteem, our nation held off on using the Voice of America to send "truth broadcasts" to Cuba. Obviously something had to be done—but who was to do it, and how?

The national media and (presumably) Washington was mulling over various possibilities when suddenly something took place to change the status quo. Without any warning whatsoever, a broadcaster calling itself Radio Swan appeared with a 50 kW signal (3.5 kW on 6.000 MHz shortwave).

And where was it operating? Right on 1160 kHz (measured 1157 kHz), a "clear

channel" which, until then, had been mainly occupied by KSL in Salt Lake City and WJJD in Chicago, both 50 kilowatters. Listeners throughout North America reported the RS signals on 1160 kHz, while the 6 MHz signals were heard over a far wider area.

Not only that, the RS programming was mainly a wealth of very strong anti-Castro sentiment, far sharper than would have been attempted by the VOA.

## ***A Mystery Wrapped In An Enigma***

The immediate question was, "Who or what is Radio Swan, and by what authority was it operating on 1160 kHz?" It soon became apparent that the station was a fantastic bootlegger that had brazenly "allegedly found a means of issuing a license to itself" (as put by Jack Gould in *The New York Times* of 5 April 1961) and had generously assigned itself a choice operating frequency.

Station KSL complained vigorously but their pleas did no good, as RS claimed that their signal pattern was directed away from

Salt Lake City. Even if the RS signal was directed right at KSL, it wouldn't have made any difference since no governmental authority had ever been granted for the RS station to exist. It seemed to be operating outside of all international broadcasting agreements and treaties. Oddly enough, RS claimed to be an American station and, furthermore, the station announced that it was beginning to line up commercial sponsors for its programs!

The station claimed that its transmitters were located on Swan Island, a tiny and forlorn chunk of limestone and coral between Cuba and Honduras. Some DX fans doubted these claims.

## ***Swan Island, What?***

The Swan Islands (there are two of them) were actually an interesting choice for the location of RS since their own heritage (at that time) was a matter of controversy. Honduras claimed ownership of the islands because, under Honduran Law, the islands lie within their territorial waters (they're 97 miles offshore).





Swan Island lies between Honduras and Cuba.

The easternmost island, "Little Swan," is uninhabited. The western island, "Great Swan," is 2 miles long by 1/2-mile wide, and was inhabited by 20 Cayman Islanders who were brought there by the Americans to work as laborers. There were also employees of the U.S. Federal Aviation Agency, the Weather Bureau, the RS personnel, plus millions of iguanas (lizards)!

Regardless of the claims Honduras had on the islands, in 1863 they were declared to be an American possession (by an Act of Congress). To further complicate the situation, a Mr. Sumner Smith of Boston claimed that the islands were his personal property and that all who used the land there pay rent to him. Smith was the vice president of RS!

Shortly after RS went on the air, Honduras decided to take a stand on its ownership claim. About a dozen brave souls set out in a small rented boat for an "invasion" of the islands. After a rough trip they "stormed the beach" and asked if anybody could provide them with seasickness remedies. They also wanted to know where they might run up a Honduran flag. The invaders were shown a cordial welcome by the Americans (including the RS staff), and given a spot to fly their flag. After the flag ceremony, luncheon was served by the RS staff and the invaders offered the Americans a gift of a bottle of Honduran "Scotch" as a goodwill gesture. The invaders then sailed back to Honduras. A good time was had by all!

### The Status Of RS

The Swan Islands, being considered by Uncle Sam as an American possession, were administered by various federal agencies. The FCC has long given out Amateur Radio licenses (KS4 prefix) for the islands, thus affirming our government's claims to control of the islands. However when the question of RS' official status was tossed at the FCC, they were in a quandry. On 16 September 1960 they wrote to me stating, "In response to your letter . . . you are advised that the Commission has no information regarding the radio operations to which you refer." Can you imagine a similar FCC reaction to a 50kW bootlegger in Los Angeles or Houston?

Ironically, the FCC eventually issued the staff at Radio Swan a license for their Amateur Radio Club; the call sign was KS4CC!

An inquiry about RS was also sent to Honduras and was answered, "We wish to inform you that Radio Swan, located on Honduras' Swan Islands, has neither solicited nor obtained government permission to operate on Honduras territory."

### Castro In A Snit

Fidel Castro was enraged about the appearance of the station and he took quick action. In Cuba there had been a few small broadcasters on or near 1160 kHz—CMDX, CMBQ, CMJK and others. Castro announced that these would be leaving the air and replaced by a new high-powered station, CMBN, La Voz del INRA, which would jam Radio Swan. The broadcast (and noise) jamming was only partially effective on an island-wide basis, however, Castro also made it illegal for Cubans to listen to RS.

Furthermore, in September of 1960, Castro showed up at the United Nations and angrily denounced Radio Swan. He said, in part, "In the Caribbean Islands is a territory which belongs to Honduras and which is known as the Swan Islands, and the Government of the United States has taken over this island. It has set up a very powerful broadcasting station which it has placed at the disposal of war criminals and the subversive groups that are being sheltered by this country."

### War Criminals?

Radio Swan, at that time, was owned by the Gibraltar Steamship Corporation of New York City, a company that did not own a single steamship. The company was acting as a regular commercial broadcaster, and had lined up sponsors such as R.J. Reynolds Tobacco, Radio Bible Class, Accion Cristiana Dominicana, The World Tomorrow, Philip Morris Co., Kleenex, and others. News broadcasts were sponsored by "the Cuban Freedom Committee of an American anti-Communist Foundation known as the Christianform."

The president of Gibraltar Steamship was

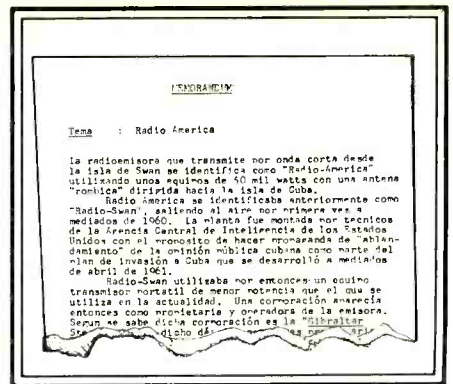

One of my information sources was this report provided me by Cuban nationals employed at one time by RS/RA. This is part of one of these memos. In the second paragraph the memo notes that the plant (transmitter) "was constructed by technicians of the Central Intelligence Agency of the United States."

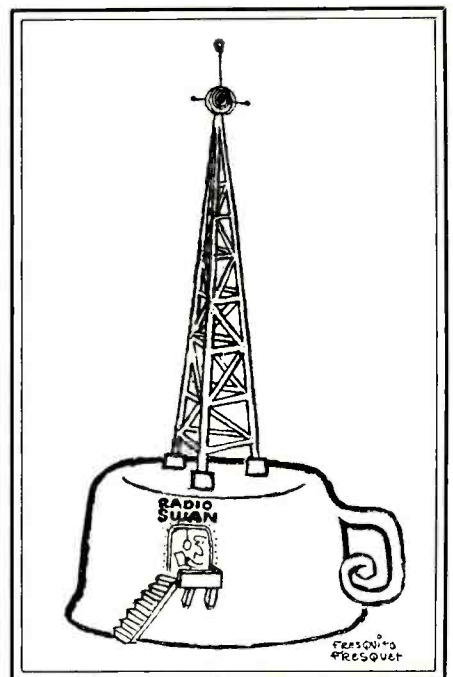

Cuban publications fought back against Radio Swan with wry humor. This cartoon compares RS to a chamber pot. The analogy is pretty obvious.



Fidel took direct action against RS by establishing his own high powered broadcaster right on the RS frequency.

9BRD priat  
Amateur Radio Station

# KD4HHS

GEORGE M. GROVER, OPR.

RADIO: *W8ADG* thanks for *14* Mc. contact *May 9, 81*  
at *7:40 AM, 1 ST.* *Thx for QSL!* Hallicrafters HT-9  
Xmtr, 100 W. Rcvr: 2 AR-77's Ant: 2-element Beam

**SWAN ISLAND, West Indies**



The Radio Americas QSL claimed the station was on Swan, however, a noisy group of hardcore skeptics refused to accept that location as accurate. The more RS/RA said it was on Swan, the more certain were the skeptics that it was elsewhere.

The FCC was hard pressed to explain why RS/RA was operating minus a license inasmuch as the agency had long issued licenses for transmitters there. The FCC's ham prefix for Swan was KS4, however this QSL from a 1940's Swan operator shows that in earlier days Swan had a KD4 prefix.

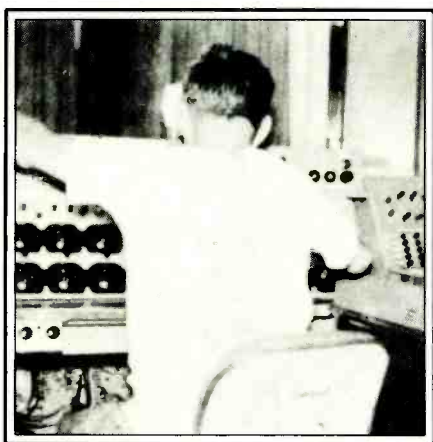

This 1960 photo supplied by RS was careful not to show the technician's face.

of 15 engineers and technicians who were employees of The Philco Corporation's Tech Rep "flying squad," which provided these people on a "for hire" basis. Operators were sent to Swan for a six month hitch.

Food supplies, diesel fuel for the generators and heavy equipment for RS and other installations on Swan came from Tampa, Florida aboard the M/V Don Emilio B., an ex-U.S. Navy LCI operated by The Hamilton Brothers Steamship Co. A small pier on the island offered the only docking available and it was, at best, very poor. The LCI had to anchor off shore and send a rowboat to the pier.

### Bay Of Pigs

It was during the Bay of Pigs invasion of April, 1961, that RS took a new turn in its broadcasting career. Immediately prior to the invasion, and throughout the event, RS broadcast an almost endless stream of cryptic messages. One typical message was, "Attention, Stanislaus, the moon is red 19 April." Other messages were overt battle instructions to specific military units. Whether

or not any of these were valid messages or were simply a matter of psychological warfare intended to impress or frighten the Cubans has never been determined.

The RS activities in connection with the Bay of Pigs fiasco caused a number of RS-watchers to come to the conclusion that, regardless of its commercial facade, Gibraltar Steamship Corp. was your basic CIA spook or front type of black operation. In fact, the 1 May 1961 issue of *Newsweek* referred to RS as a CIA operation.

After the Bay of Pigs, Gibraltar Steamship moved its headquarters to Miami and inexplicably changed the station's name to Radio Americas. In 1962, Gibraltar Steamship was phased out and the new "owners" of the station became the Vanguard Service Corp., which claimed it was a firm of "business consultants." In time, Vanguard turned over the station to another CIA front, Radio Americas, Inc. of Coral Gables, Florida.

RA continued in operation under its revised status. The actual operation of the station in its Florida days was under two men, Robert J. Wilkinson and Orlando Alvarez, although most of the corporate officers of

Thomas Dudley Cabot, not only a former President of the United Fruit Company, but also a former Director of The Office of Internal Security at the U.S. Department of State!

When asked about how this American owned (and largely American staffed) station was able to operate from American territory without an FCC license, they did have an answer! They said that they had not applied for an FCC license because they weren't satisfied with the U.S. claim to the ownership of the islands, and that they could effectively fight the American claim to the islands if they wanted to (although they had no intention of pursuing the matter). (In 1973 the U.S. relinquished its claim to ownership of the Swan Islands and they were ceded to Honduras.)

The RS programs were in both Spanish and English and ranged from anti-Castro (and anti-Trujillo) types to musical and religious offerings. Taped in the United States, most were flown to the island by chartered plane from Miami (via Cozumel, Mexico). News programs were prepared in New York and sent to the station daily via RCA commercial point-to-point circuits.

The RS technical staff on Swan consisted

Another 1960 photo shows the Miami-based aircraft unloading mail and packages on Swan. Again, all RS technicians face away from the camera.





**Personnel Directory**

Listed here are the companies concerned with the operation of Radio Americas and predecessor Radio Swan, along with the officers of these companies and, in some cases, their other business connections.

**Gibraltar Steamship Corp. (1960)**

Pres.: Thomas D. Cabot, Weston, MA  
 Director, 1st Natl. Bank, Boston  
 VP: Sumner Smith, Lincoln, MA  
 Owner of Swan Island(s)

Stockholder: Walter G. Lohr, Baltimore, MD  
 Commercial Mgr.: Horton H. Heath, New York, NY  
 Program Dir.: R. J. Wilkinson, Miami, FL  
 Operations Mgr.: Roger C. Butts, Miami, FL

**Vanguard Service Corp. (1962)**

Pres. & Treas.: Leon D. Black, Miami Shores, FL  
 VP: Robert R. Bellamy, Miami, FL  
 Investment broker  
 Secy: Frank J. Kelly, Coral Gables, FL  
**Radio Americas, Inc.**  
 Pres: Roosevelt C. Houser, Coral Gables, FL  
 Director, 1st Natl. Bank, Miami, FL  
 VP: W. R. Maddux, Miami, FL  
 Maddux & Co., real estate  
 Secy: Treas.: Walter S. C. Rogers, Coral Gables, FL  
 Pres.: Florida Bond & Mortgage Co.  
 Program Dir.: R. J. Wilkinson, Miami, FL

**Former Vanguard Officers**

Pres.: William H. West, Jr., Millwood, VA  
 VP, Farmers & Merchants Natl. Bank, Winchester, VA  
 VP: James E. Hollingsworth, Palm Beach, FL  
 Director, 1st Natl. Bank, Palm Beach, FL  
 VP & Genl. Mgr.: Mr. Butts, then of Hollywood, FL  
 Former employee, W. R. Maddux  
 Secy: Richard S. Greenlee, New York, NY  
 Attorney  
 Commercial Manager: Mr. Heath  
 Program Dir.: Mr. Wilkinson  
 Office Mgr.: Frederick Fazakerly, Miami, FL  
 George Wass, address unknown

the station were always persons with important banking or other financial positions.

Wilkinson, a Cuban-American, had been with the station since its early days. His official title was Program Director. Cubans in Miami identified him as the CIA agent in charge of the station.

In pre-Castro Cuba, Wilkinson was a well-known producer/performer for the CMQ radio network.

Alvarez, in pre-Castro Cuba, had owned the important Radio Cadena Habana (stations CMCH and COBH).

These two men headed a staff of more than 30 persons in Miami—artists, newspapers, and technicians. They also controlled the Cuban newscasters and the technicians stationed on Swan.

In this period, RA was producing many of its dramatic, comedy, and soap opera programs (most with an anti-Castro flavor) at the Continental Recording Studios, 2020 N.W. 7th Street, Miami. Continental was operated by Aldo Vazquez, although the second banana there was RA's Orlando Alvarez. The recordings were directed by Angel Fernandez Varela, former director of the Havana newspaper, *Informacion*. Many of the commentary programs were narrated by Cuban counter-revolutionary Luis Conte Aguero.

The remainder of the taped shows were recorded off the air from broadcasts of Radio New York Worldwide, WNYW. The voices of "Havana Rose" (as she was known) and Luis Conte Aguero were usually recorded

by RA from the WNYW transmissions.

Cubans in Miami to whom I spoke in the Summer of 1967 said that RA had become something of a bore, with its unrelenting anti-Castro torrent of words. Fact was, they said that the folks in Cuba had acquired a taste for the soft-sell VOA 1180 kHz station in Marathon, Florida (the station reborn in 1985 as Radio Marti). RA had, however, acquired a rather large audience throughout Central and South America, where its anti-Castro message was backfiring. It seems listeners figured that if the U.S. was spending so much money to knock Castro he must be far greater and more important to Latin America than it would otherwise appear.

**The Moment Of Truth**

Within DX circles, RA had become entrenched as one of the hottest topics of discussion throughout the 1960's. After years of broadcasting, during which it never varied so much as an inch from its claims that it was on Swan Island, there were those who continued to insist that the announced Swan location was a CIA diversionary tactic to draw attention away from the true (and secret) location. In fact, the longer the station announced it was on Swan, the more certain were some that it was elsewhere!

Some DX'ers speculated that RA was in south Florida, aboard a ship at sea, Cay Sal in the Bahamas, Venezuela, or Navassa Island. The reasoning and logic employed by some members of the DX'ing community

**RECEIVING ACCESSORIES**

**CONVERTERS**

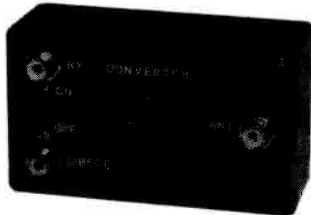

WIRED AND TESTED TO YOUR FREQUENCY

- VLF — 30-500 Khz . . . . . \$39.95
- AIRCRAFT — 108-136 Mhz . . . . . \$49.95
- PUBLIC SERVICE — 150-170 Mhz . . . . . \$49.95
- AMATEUR — 144-148 Mhz . . . . . \$49.95

\*Indicate 14 Mhz or 28 Mhz receiving range  
 VLF converter normally 3.5-4 Mhz output

**DX ANTENNA TUNER**



- EFFECTIVELY INCREASES THE LENGTH OF YOUR ANTENNA
- PROVIDES A BETTER MATCH BETWEEN ANTENNA AND RECEIVER

KIT — \$19.95  
 WIRED AND TESTED \$29.95

**MORNING DISTRIBUTING CO.**

P.O. BOX 717, HIALEAH, FLORIDA 33011

PHONE: (305) 884-8686

SEND FOR OUR NEW BROCHURE ON HOBBY KITS!

BUILD RECEIVERS, TRANSMITTERS  
 TRANSCIVERS  
 Send For Hobby Kit Brochure

Add \$2.50 Shipping and Handling

CIRCLE 146 ON READER SERVICE CARD

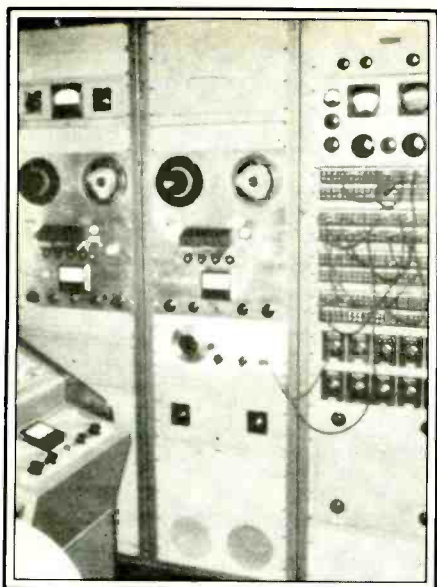

Ampex tape decks, Super-Pro receiver and a patching board show in this 1960 photo of the equipment used at RS to record some programs from stateside transmitters.

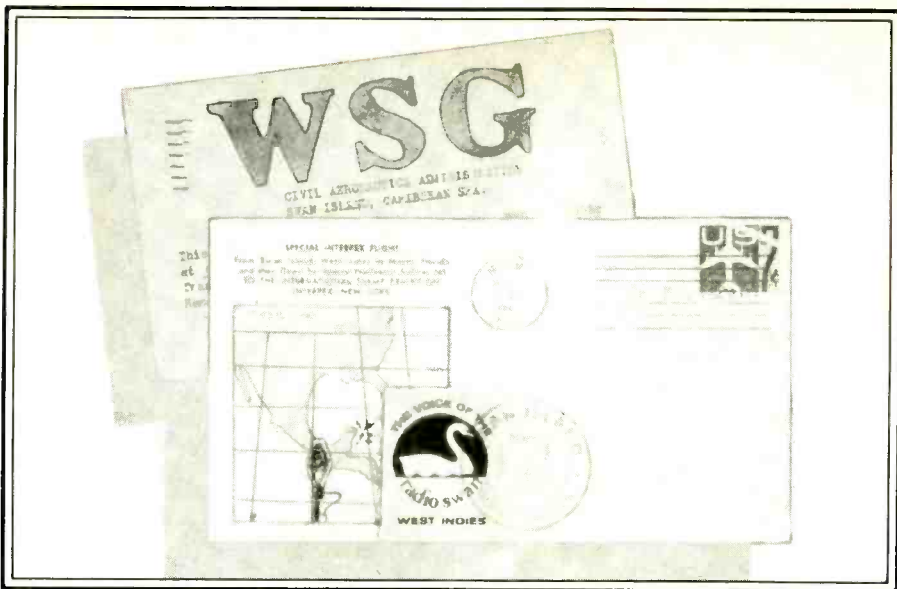

U.S. claims to control over Swan are backed up by a QSL from station WSG (the FAA on Swan) mailed in 1950. On 17 March of 1961 RS itself sent out special letters bearing American postage stamps, even though the FCC claimed it was unaware of the existence of the 50 kW station.

was usually preposterous, convoluted, and esoteric in an effort to prove that the station was at a location other than Swan. Perhaps, what with the CIA involved, the notion of a secret location was a cheap thrill to some.

One perfect example of the way in which this "controversy" was fed and perpetuated appeared in the May, 1963, edition of *Electronics Illustrated* magazine. Ontario DX'er C.M. Stanbury II solemnly announced that he had devised a "Short Wave Fraud Finder" antenna that would supposedly settle the matter. Let it be noted that this outlandish super whizbang skyhook consisted of nothing more than two wires, one strung in a vertical plane and the other horizontally. The idea was to compare various S-meter readings between the two antennas so the CIA's mysteries would be revealed.

After setting his "Fraud Finder" contraption into action, Stanbury finally revealed, "Tests I ran on several evenings . . . indicated R. Americas was *not* on Swan Island . . . RA is much nearer Cuba than it is to Swan . . ." The mystery-solver further proclaimed that those DX'ers who maintained that RA was on Swan only did so because, "A good many DX'ers would rather cling to that theory than drop a rare country from their logs . . . We see no reason why its location (RA) should be kept secret at this late date."

Notwithstanding such ominous charges, RA blithely continued in operation, eventually shifting its broadcast band frequency slightly to 1165 kHz, and opening up a second shortwave frequency of 11800 kHz.

By 1968 DX'ers were still quite fascinated with RA and its activities; there was scarcely a DX club bulletin that didn't discuss the station in every issue. I had done quite a bit of writing in national magazines about RA and I figured that my efforts had been noticed by Gibraltar Steamship, Vanguard Service, Radio Americas, Inc., or whomever.

It therefore crossed my mind that it might be interesting to see what would happen if I contacted RA and tried to convince them that it would be a great idea to permit me to travel to Swan to check out the hardware to make certain that they weren't trifling with the emotions of the DX fraternity—and while I was there I could take some pictures and chat with the personnel. True, after RA began broadcasting, the island became off limits to casual visitors (although an elderly couple from Boston had been permitted to go there each year to count the birds), but when I told them how important it was for the DX'ing community to know for sure, they'd certainly understand. That, at least, was my fantasy.

I discussed my brainstorm with Bob Beason, the editor of *Electronics Illustrated*, hoping that he might be interested in publishing the story of my proposed visit to Swan. He regarded with total incredulity my idea of asking RA if I could visit Swan. Finally he facetiously said, "Sure—and ask them if I can tag along with you!"

Without delay, I dashed off a letter to the RA office and bluntly asked if I could stop by their transmitting site, take some photos, and rap with the engineers. Also, I added that I wanted to bring someone along to verify my findings. It was a lark, I'll admit.

To my amazement, RA's Bob Wilkinson came back with the answer that we would be welcome on Swan as long as we had permission from the FAA (which, he said, had control over the island). In addition, we would also have to provide our own transportation since no regularly scheduled airline flights or cruise ships stopped at Swan. We envisioned miles of red tape in order to get FAA approval. Beason felt FAA approval was a "Catch 22" to keep us off Swan.

As things turned out, the FAA was the very least of our problems and their quick

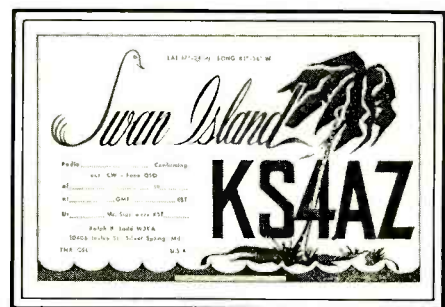

The last civilians allowed to visit Swan before RS made it off limits were hams W4KFC, W3KA, and W4JNE, who received the callsign KS4AZ for their DXpedition in February of 1960. They did not report seeing any preparation for RS, which went on the air only two or three months after their visit. Obviously RS was tossed into operation on little more than a moment's notice. My own visit to the island revealed that RS was a highly portable station with many components in mobile vans. More on this in the next issue of POP'COMM. The story of the KS4AZ DXpedition was told in the May, 1960, issue of CQ magazine.

approval opened the way for a strange and eerie excursion that culminated in our flight aboard a chartered 1938-vintage DC-3 aircraft heading toward the grass runway on Swan, a runway that the pilot insisted might be too short to land a DC-3, and probably was unsuitable for us ever to use for taking off to return to civilization.

Was there a 50 kW clandestine CIA broadcaster on this strange little speck of rock? You betcha! Was it ever, and I'll tell you about it and show you some of the photos I took in Part II appearing in the next (December) issue of POP'COMM. Watch for it!

PC



# Copy Worldwide Short-wave Radio Signals on Your Computer

Remember the fun of tuning in all those foreign broadcast stations on the short-wave radio? Remember those mysterious sounding coded tone signals that baffled you? Well, most of those beeps & squeals are really digital data transmissions using radioteletype or Morse code. The signals are coming in from weather stations, news services, ships & ham radio operators all over the world. Our short-wave listener cartridge, the "SWL", will bring that data from your radio right to the video screen. You'll see the actual text as it's being sent from those far away transmitters.

The "SWL" contains the program in ROM as well as radio interface circuit to copy

Morse code and all speeds/shifts of radioteletype. It comes with a cable to connect to your radio's speaker/earphone jack, demo cassette, and an excellent manual that contains a wealth of information on how to get the most out of short-wave digital DXing, even if you're brand new at it.

For about the price of another "Pac-Zapper" game, you can tie your Commodore 64, 128 or VIC-20 into the exciting world of digital communications with the Microlog SWL. \$64. Postpaid, U.S. MICROLOG CORPORATION, 18713 Mooney Drive, Gaithersburg, Maryland 20879. Telephone: 301 258-8400.

## MICROLOG

INNOVATORS IN DIGITAL COMMUNICATION  
CIRCLE 62 ON READER SERVICE CARD

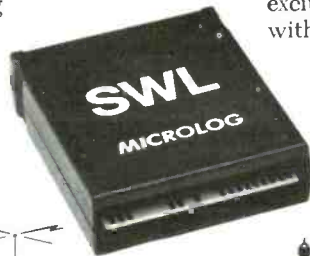

## Coming Soon In POPULAR COMMUNICATIONS



- We Visit The CIA's Radio Paradise: Part II
- Eavesdropping On Radio's Rock Bottom
- Scanning The "Nowhere Band"
- Tristan: Most Wanted DX Catch
- Tuning In With The Pros

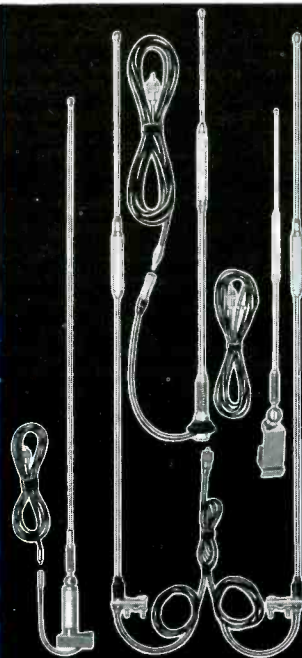

# CB...

# GO WITH THE LEADER...

# HUSTLER.

# CB ANTENNA PRODUCTS

THE STANDARD OF PERFORMANCE



3275 North Avenue B  
Kissimmee, Florida 32758  
(305) 933-0500

An **AMTRON** Company



# SHORTWAVE HEADQUARTERS

EEB THE NATIONS LEADING SWL SUPPLIER

You can count on the Electronic Equipment Bank for:

- The very latest in SWL products
- Fast delivery from our huge inventory
- Big savings on our discount prices
- Friendly knowledgeable sales help
- Full service on ESKA-ICOM-Kenwood-Yaesu
- Easy ordering with our toll free phones

## NEW COMPUTER CONTROL INTERFACE BY M.E.C.



ICOM R71A

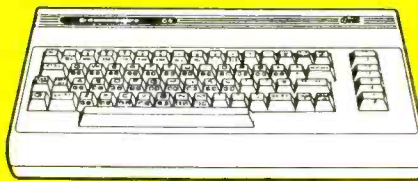

Commodore C64/C128

Microcomputer Electronics Corporation now offers the M.E.C. 71 $\alpha$  Computer control interface that will control and *expand* the capability of the ICOM R71A.

- **Memory Expansion** - The computer can store up to 705 memories, listing UTC Time, Frequency and Mode plus space for your notes. To save your 705 memories a disc or cassette is required.
- **Memories Unlimited** - By use of the Disc it is possible to have an unlimited memory bank. You can build up Discs for each 1 MHz Band or each SWL Band, or a Disc for RTTY. It is only limited by your imagination.
- **Auto Log** - A simple press on a key and you have logged your station automatically entering U.T.C. Time, Frequency and Mode. If you wish to add a note, O.K.
- **Scanning** - Full feature Scan between any two programmable limits. You control sweep rate and signal level desired to stop scanning.
- **Memory Display** - All 32 internal Memory Channels of the R71A are displayed on the screen showing number, frequency and mode. Memories can be changed directly from the key board.

- **Higher Resolution** - R71A displays to 100Hz. M.E.C. 71 $\alpha$  gives you 10Hz resolution, control and memories to 10Hz.
- **Built-In UTC (24 Hour) Time Display**
- **V.F.O./Memory Exchange** - By the press of a key you can exchange the radio frequency/mode with whatever memory channel is on display, making 32 channels of the R71 memories easy to load or change.
- There are many features too involved to list here. Send SASE for complete flyer with photos and details.

ICOM EX309 (interface connector) must be installed in the R71A (see options below)

• No modification to the R71A required.

**Price to be announced - CALL Available Fall 85. Dealer inquiries invited. E.E.B. is the exclusive Distributor for Micro-computer Electronics Corp. products worldwide. Address all correspondence to E.E.B.**

### ICOM IC-R71A "A World Class Receiver"

- 100KHz-30MHz
- Keyboard entry
- 32 Programmable Memories
- SSB/AM/RTTY/CW (FM Optional)
- Wide dynamic range
- Digital PLL Synthesized
- Memory scan
- Pass Band and Notch Tuning
- List \$799.00 E.E.B. Sale \$649.95 plus \$8.00 U.P.S.

#### COM OPTIONS

- DK-70: DC Connector Kit for External 13.8 VDC Operation ..... \$9.95
- DR-64: High Stability Oscillator (see "Stability" specs above) ..... \$56.00
- EX-31D: Voice Synthesizer Push a Button and Hear the Frequency ..... \$39.95
- EX-25T: FM Unit. FM mode used only 29.5 to 30 MHz by amateurs. Some police. (Note you will not hear any music) ..... \$38.00
- FL-32: CW Filter 500 Hz (9 MHz) for those interested in CW ..... \$59.50

- FL-44A: SSB Filter 2.4 KHz (455 KHz) 8 pole crystal filter. (Read details in WRTH review this page). \$159.00
- FL-63: CW Filter 250 Hz (9 MHz) narrower filter than FL-32 above. .... \$48.50
- RC-11: Remote control. Operate your R71A across the room by remote control. Controls most all functions. (Requires Installation of circuit board inside R71A (included)). ..... \$59.95

**INSTALLATION** ... options can be installed by a skilled user/owner. **EEB** will do it for you!

- 1-3 options ..... \$35
- 4 and up ..... \$45

#### EEB OPTIONS (INSTALLED ONLY)

- 1. 24 hour bench test, complete realignment for optimum performance and extended 6 month warranty. .... \$40
- Option #1 is prerequisite for any options installed by EEB**
- EXTENDED WARRANTY APPLIES ONLY TO NEW R71A SALE**
- 2. Mechanical 2.4 KHz filter—replaces stock ceramic filter—improves SSB, ECSS, AM narrow selectivity. .... \$95
- 3. Front end upgrade—improves dynamic range (plus) pre-amp enable below 1600 KHz. .... \$35
- 4. 4 KHz filter replaces stock 6 KHz wide filter improves AM selectivity ..... \$50
- 5. Audio output increases audio power, reduces distortion ..... \$35

## KENWOOD SALE



### SPECIAL SALE

- R-600 ..... \$319.95
- R-1000 ..... \$399.95
- R-2000 ..... \$479.95

**Free EEB 6 month extended warranty included!**

### SONY ICF-2010

- 150 kHz to 30 MHz AM,CW,SSB
- 76 MHz to 108 MHz FM
- 116 MHz to 136 MHz AM Air Band
- 32 Programmable Memories
- 4 Event Timer
- Synchronous Detector
- Wide/Narrow Bandwidth



**"This is one of the finest receivers available today under \$500"**  
List \$349.95 EEB Sale **\$279.95+** \$6 UPS

### SONY ICF 2002

- Ultimate compact HiTech at an affordable price
- 25% size of famous SONY ICF 2001, SONY's best seller
- 150 kHz - 30 MHz
- AM, FM
- Memories
- Keyboard entry
- Scan
- 24 hour clock



**\$199.95**

### SONY ICF 4910

- Ultra small pocket size
- AM, FM, 7 SW most popular bands—13, 16, 19, 25, 31, 41, 49 meters
- Safety lock
- Batteries (2) AA
- Optional AC power
- Sale \$99.95



### TOSHIBA RP-F11 (KENWOOD R-11) Xer's Dream



Full page in 1985 WRTV inside front cover for details

- Covers all International & Tropical Bands
  - S Meter, Safety Off Lock
- SAVE \$50.00 SPECIAL SALE \$79.95**

A special EEB purchase makes this price possible

Hurry, limited quantity at this price

Optional AC wall adapter \$11.95 add \$4.00 UPS

### NEW! Sony ICF 2010 \$289.95

- Sony ICF 2002 Extra special ..... \$199.95
- Sony ICF 4910 ..... \$99.95
- Panasonic B300 Extra special ..... \$179.95
- Panasonic B600 ..... \$429.95
- Panasonic RF9 ..... \$79.95
- Sharp FV310 Close out ..... \$79.95
- Sharp FV610 Close out ..... \$119.95

### WORLD RADIO TV HANDBOOK

- Shortwave Listener's Bible
- All SW Stations Listed
- Addresses and Schedules
- Languages and Target Areas
- Equipment Review
- No SWL'er should be without one



**Special \$19.50 postpaid U.S.**





Advanced Electronic Applications

# SWL-TEXT™

## CP-1 Computer Patch™



SWL-TEXT is the software and CP-1 is the interface that when combined with your Commodore C64™ and communications receiver, will give you everything you could ask for in a CW/RTTY intercept station!

- Automatically determines RTTY speed and indicates if ASCII or Baudot
- Copies AMTOR, ARQ and FEC
- Samples data to determine bit inversion and transposition pattern
- Complete printer control
- 24 hour clock
- Complete buffer control with the ability to store buffer on tape or disk
- Complete with all cables for Commodore C64
- Copies CW 5 to 99 WPM
- Copies Russian RTTY and Japanese RTTY & CW

Our Lab Has Checked Them All. This Is The Ultimate.

SWL-TEXT/CP-1 Special Introductory Package Price **\$269.95**  
List \$329.90

Uninterrupted  
Frequency  
Coverage  
100 kHz to 1400 MHz  
with Optional Converters

# J.I.L. SX-400



- A professionally created scanner for the serious listener
- Wide frequency coverage 26 to 520 MHz (with optional converters 100 kHz to 1400 MHz)
- Continuous coverage. You'll hear everything.
- Birdie-Free, no internal 'signals' to interfere with scanning
- 20 Channel memory, AM-FM Mode memory, Priority memory
- Carrier Operated Relay (COR) permits automatic start/stop of a recorder
- Four low-noise front end converters for optimum performance
- 12 Volt DC operation (120 Volt AC power supply optional)
- Check JIL's ad in this issue for further details

Sale Price **\$549.95** List **\$739.90**  
P-1A Power Supply **\$34.95**  
Optional converters in stock call

**SPECIAL SALE**  
**\$499.95 + \$8 UPS**

### YAESU FRG-8800

THE ALL NEW  
8800 IS HERE.

IT'S FANTASTIC

**\$539.95**

Introductory Price



The FRG-7700 was a great receiver. Now the new generation FRG8800 takes you a step forward.

- CAT computer compatible
- 12 memories - scan- RIT
- Keyboard frequency entry
- Dual 24 hour clock timer recorder control
- Optional FRV8800 VHF converter 118-174 MHz \$99
- All mode AM - SSB - CW - FM
- Green LCD display
- 150 kHz to 30 MHz

#### EEB Exclusive Options

1. 24 hour bench test and complete realignment for optimum performance including double-extended warranty \$40
2. 4 kHz ceramic filter replaces 6 kHz AM Wide ceramic filter Installed \$50
3. 2.4 kHz mechanical filter replaces SSB ceramic filter Installed \$95

#### SHARP CLOSEOUT SPECIAL

FV-610 **\$119.95 + \$4.00 UPS**

- Digital read-out
- Clock
- AM, FM - 13, 16, 19, 25, 31, 41, 49 meter bands and longwave 150-285 kHz

FV-310 Same basic radio without digital readout **\$79.95 + \$4.00 UPS**



### New YAESU FRG9600

A premium VHF/UHF  
scanning communications receiver.



The 9600 is no typical scanner. And it's easy to see why. You won't miss any local action with continuous coverage from 60 to 905 MHz.

You have more operating modes to listen in on: upper or lower side-band, CW, AM wide or narrow, and FM wide or narrow.

You can even watch television programs by plugging in a video monitor into the optional video output.

Scan in steps of 5, 10, 12½, 25 and 100 KHz. Store any frequency and related operating mode into any of the 99 memories. Scan the memories. Or in between them. Or simply "dial up" any frequency with the frequency entry pad.

Plus there's much more, including a 24-hour clock, multiplexed output, LCD readout, signal strength graph, and an AC power adapter.

**List \$599.95 Special Sale \$499.95**

SONY • PANASONIC • TOSHIBA • BEARCAT • JIL • SHARP • UNIDEN • MIZUHO • REGENCY  
• ICOM • KENWOOD • YAESU • ESKA • PALOMAR • MFJ • Book department—all accessories

**Write or call today for our 1985 catalog**  
**800-368-3270**



- We ship world-wide
- FREE Catalog in US
- All Others 3 IRC's for Air Mail
- Shipping charges not included
- Prices & specifications subject to change without notice



10 miles west of Washington, D.C.  
Sorry—No COD's  
10-5 Tues., Wed., Fri.  
10-9 Thursday  
10-4 Saturday  
Closed Sunday and Monday

**Electronic Equipment Bank**  
516 Mill Street, N.E.  
Vienna, Virginia 22180

**Order Toll Free 800-368-3270**  
Virginia 703-938-3350

# Monitoring International Terrorists

## *Each Terrorist Crisis Produces A Flood Of Communications!*

BY ANTON KUCHACEVICH ze SCHLUDERPACHERU

**T**here are approximately 200 terrorist organizations presently operating throughout the world. They include groups connected with Sikh, Croatian, Basque, Shiite and other Moslem, as well as various additional religious and political movements and causes. Some of these groups have only a handful of members, while others are well organized and highly coordinated.

Right now, about 40% of terrorist activity is directed against American interests on a worldwide basis. Commencing with the 1968 terrorist attempt (failed) to skyjack an Israeli airliner, terrorists have spent an inordinate amount of time and effort in concentrating on international air travel and its related ground facilities. Terrorists, one may easily assume, are not especially innovative and are much into imitating and repeating previously tried and proven efforts. Moreover, many groups are not at all beyond attempting to take false credit for the dirty work done by other groups!

While airports in Greece, Turkey, France, Italy, Spain, and Libya have been the departure or arrival points for any number of international skyjackings, the airport at Beirut (Lebanon) has been somehow connected with no less than 15% of terrorist activities directed against airlines operating outside of the United States!

There have also been terrorist acts against airports in New York City, Rome, Madrid, Frankfurt, and elsewhere. These acts have usually consisted of explosive devices placed in baggage or storage lockers.

### **The Terrorist Connection**

While some of the world's approximately 200 terrorist groups are independent and totally isolated, many have at least one degree or another of coordination and inter-communication with other groups. These contacts, usually by HF radio communications, may be with other "field" organizations or with headquarters stations located in nations that are friendly to, tolerant of, or outright supportive of international ter-

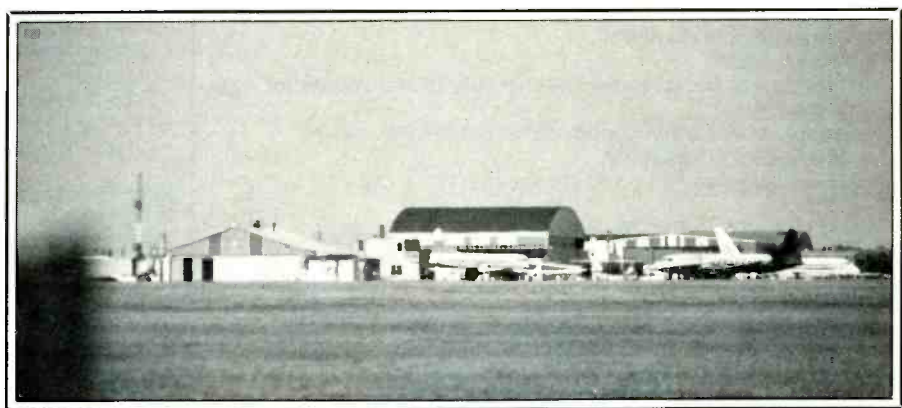

rorism, including Libya, Iran, Syria, and others.

The frequencies used for such communications come from two primary selection areas; they are either adjacent to the 20 and 40 meter ham bands or they are frequencies authorized for simplex communications by ships on the high seas. Easily available transceivers (that require little or no modification) and pre-tuned antennas, combined with little chance of getting caught, have brought about the popularity of these frequencies.

In the realm of usage of ham equipment, tuning 6700 to 7000, 7300 to 7700, 13500 to 14000, and 14350 to 14800 kHz covers the frequencies most often selected by terrorists. Note that 13560 kHz has, from time to time, been especially popular; this frequency is allocated (worldwide) for industrial, scientific, and medical uses. As such, it isn't used or monitored by any communications services and there are few who will raise a squawk if and when it is taken over for unorthodox communications, voice or non-voice (although most terrorist groups use USB mode).

As for the maritime simplex frequencies, these are legitimately used by vessels at sea (and some shore stations) for exchanging non-critical voice communications. In fact, they often sound like a gigantic CB network with personal chit-chat and informal chatter

between skippers of ocean going tugs, tankers, freighters, trawlers, and even oil drilling rigs. Because little official monitoring takes place on any of these channels, virtually "anything goes." The informal atmosphere, difficulty in determining the exact locations of the participants, and the odd mix of languages normally encountered makes these frequencies (USB mode) prime candidates for the exchange of messages between groups up to no particular good.

Indeed, if there was ever any doubt that international terrorism is a well-coordinated effort, one has only to spend some time







Aircraft flying international routes can communicate on frequencies normally active during skyjacking. The HF transceiver in this Gates Learjet 35 is mounted in the center console at the bottom of the photo.

monitoring the maritime simplex or other popular terrorist frequencies. When they show more activity than usual, you can bet your AK-47 that within 48 hours there's going to be a major terrorist "incident." Be especially alert for communications in German or Middle Eastern languages.

The maritime simplex frequencies to watch are: 2065, 2079, 2096.5, 4125, 4143.6, 4419.4, 6218.6, 6221.6, 6521.9, 8291.1, 8294.2, 12429.2, 12432.3, 12435.4, 16587.1, 16590.2, 16593.3, 22124, 22127.1, 22130.2, 22133.3, and 22136.4 kHz.

Perhaps it's also smart to point out that terrorists aren't the only off-the-wall groups that have taken up unauthorized residence on any of these frequencies. International smugglers have also found that these accommodations well suit their own purposes and they seem to be very well entrenched, especially with Spanish language operations between 14350 and 14600 kHz. Combine the terrorists and smugglers with those legitimately using these channels and bands and you've got quite a strange mix!

### Flying High

Inasmuch as skyjacking has become well established as part of the international terrorists sack of tricks, it's worth keeping in mind that certain aeronautical frequencies are used for the handling of communications traffic that includes messages relating to skyjackings. Many major airports around the world are equipped to operate on these

frequencies and the following airports have, in the past, been monitored communicating with skyjacked aircraft. All airliners flying international routes (and most other aircraft flying internationally) are capable of operating on these frequencies. USB mode is used, along with English language.

Best bets to monitor include:

Athens, Greece: 3010, 6637, 10078, 13327, 17916, 21979 kHz  
 Beirut, Lebanon: 3013, 5538, 10075, 13330, 17931, 21943 kHz  
 Belgrade, Yugoslavia: 3010, 5532, 11351, 13336, 17916, 21940 kHz  
 Bombay, India: 3007, 6637, 8930, 10072, 13351, 17916, 21949 kHz  
 Frankfurt, W. Germany: 3010, 4687, 6637, 10078, 13327, 17931, 21979 kHz  
 Madrid, Spain: 5529, 8936, 10027, 13327, 17940, 21967 kHz  
 Paris, France: 3010, 6637, 11351, 13351, 17916, 21940 kHz  
 Rome, Italy: 4687, 5532, 10027, 13336, 17940, 21952 kHz  
 Tehran, Iran: 3013, 5532, 11348, 13348, 17937, 21961 kHz

During the hours of darkness (at transmitting sites), frequencies below 10 MHz are in heaviest use; at other times, monitor frequencies between 10 and 22 MHz.

Fortified with these frequencies you can tune in on the following day's newspaper headlines and TV "lead" stories. Here's a little inside information—the news media monitors many of these frequencies for their better "scoops."

# FREE SATELLITE TV



## 800-4-SATMAN



### NEW 24 Page Buyer's Guide With Guaranteed Lowest Prices

- Explains all about FREE 100 channel Satellite TV and how to shop for an earth station!
- Lists GUARANTEED LOWEST PRICES...we will not be undersold, save 30-50% over local dealer prices!
- Tells how to easily and quickly Install-Your-Own earth station and save \$400 or more!
- Shows how to demonstrate and sell earth stations from your home and earn extra money!

**uniden**

GALCOA

**Panasonic**

SHAPARRAL

MULTIPLY DRAKE Satelplex, Inc.

The new SATMAN Buyer's Guide is a *necessity* for any prospective or current earth station owner who wants to save big money on name brand satellite products and also earn some extra money. Buy direct, Do-It-Yourself, and save with SATMAN. Toll free ordering, no sales tax (IL only), major credit cards accepted, huge in-stock inventories available, and fast UPS shipping anywhere in U.S. Check with SATMAN before you buy...*We will not be undersold!* Call now for your free 24 page SATMAN Buyer's Guide.

## 1-800-4-SATMAN

1-309-692-9582 Illinois



5017 N. MELODY • PEORIA, IL 61614 • 1-800-4-SATMAN

clip and save

Please send all reader inquiries directly.



The WAAB/WNAC transmitter building, matching shack, and the lower part of the station's tower, circa 1936.

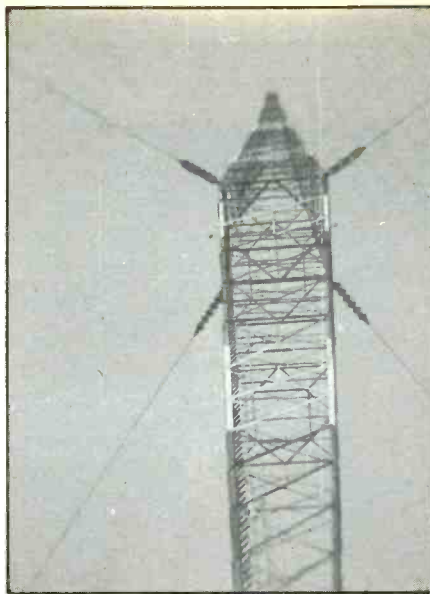

Top of the WAAB/WNAC tower, about 1936. Two stations simultaneously using one tower was quite a big deal in those years.

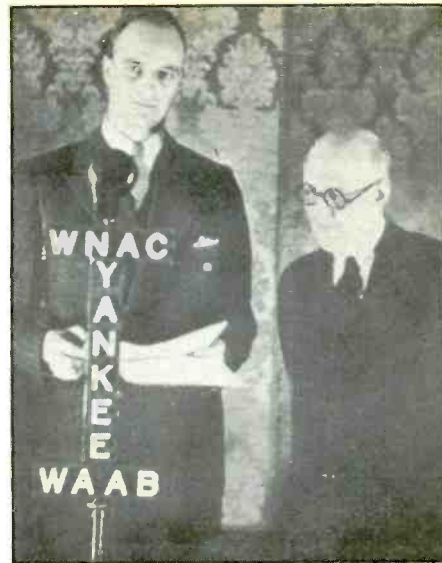

As this photo shows, WNAC and WAAB shared more than a common antenna. Both stations were members of the regional Yankee Network and at times shared studio facilities for network programming. This photo shows Jimmie Roosevelt (left) and WNAC's owner, John Shepard III, at the WNAC/WAAB mike.

# Olde Time Radio

## A Look Back Into Earlier Days

BY ALICE BRANNIGAN

**L**ooks like we have been fortunate enough to come upon rare photos of the first instance of two broadcasters to simultaneously transmit via the same antenna. Yup, thanks to W.L. Bixby of Meadville, Pennsylvania, we have no less than two photos showing the installation of stations WAAB and WNAC in the Squantum section of Quincy, Massachusetts.

Mr. Bixby comments that, at the time, it was said that it was possible for the two stations to use the same tower because their operating frequencies weren't harmonically related. The transmitting site shown in the photo was torn down early in WWII because it was in the way of an approach pattern to the South Weymouth Naval Air Station.

In checking out these two stations, we noted that WNAC had come on the air in the early 1920's from Boston, running 100 watts on 1080 kHz. At that time WNAC was owned by Shepard Stores. By 1930 the station's transmitter was still in Boston (30 Winter Street), but the transmitter was in Quincy. Operations were then with 1 kW on 1230 kHz. By 1939 the station was running 5 kW days and 1 kW at night. By 1946, WNAC had shifted to 1260 kHz; by the 1960's it was on 680 kHz with 50 kW. Today the station exists on 680 kHz as WRKO, Boston.

WAAB, on the other hand, came on the air in 1930, being operated on 1410 kHz (500 watts) by the Bay State Broadcasting Corp. of Boston (1 Winter Place). It appears that at this time WAAB was sharing WNAC's tower in Quincy. When the Quincy site was torn down, WAAB moved to Worcester, Massachusetts, changed its frequency to 1440 kHz and upped its power to 5 kW. Currently Worcester's station on 1440 kHz is WFTQ, apparently a continuation of the WAAB heritage. Records of 1946, after the "split" when WAAB went to Worcester, show its transmitter located in Holden, Massachusetts.

In our photos of WAAB/WNAC, there seems to be open wire feeding from both transmitters to the matching shack.

The trick of running two broadcasters into the same antenna is not at all uncommon these days and is being done by New York City stations WNBC (660 kHz, 50 kW) and WCBS (880 kHz, 50 kW), as well as several other stations around the nation.

### Philippines Mystery Station

Reader Dick Ipsen of Napa, California shares with us two mystery photos he came across at a flea market. Our guesstimate is that the photos are from the 1930's. Both



WNAC developed a 2-microphone mixing method used for music reproduction. In this 1923 photo, CE Sam Curtis shows off this device. One microphone was specifically designed to pick up the bass tones normally lost in early broadcasting.

show an unidentified radio installation in the Philippines.

Written in longhand on the reverse of the taller (vertical format) photo is the notation: "One of the 3 wireless towers 650 feet high. Also the causeway connecting Cavite with the main Island of Luzon."

The wider of the two photos is marked "Island of Cavite. Picture taken from top of wireless tower. First building on the right of big white building is the Marine Barracks."

We can assume that the photos were taken by one of the technicians affiliated with this station, but what station was it? An



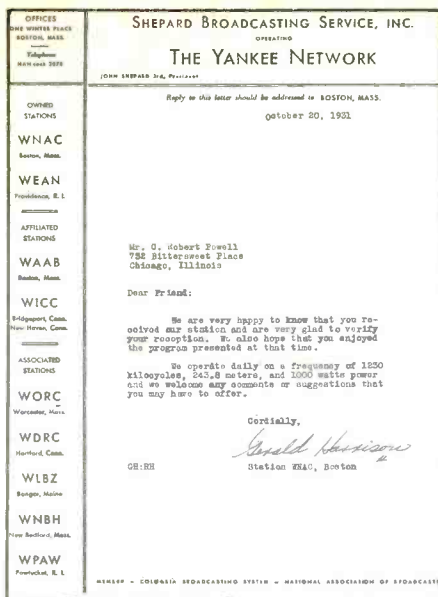

The WNAC letterhead spells out the 1931 status of The Yankee Network, including WNAC and WAAB.



The U.S. Navy base at Cavite, as seen from the top of a 650 ft. wireless tower during the 1930's. Cavite is very close to Bataan and Corregidor, where two of the bloodiest battles of WWII's Pacific theatre took place.

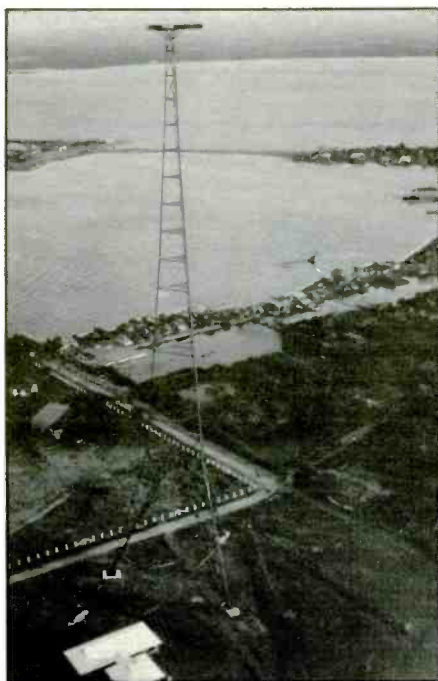

We think that this tower is one of the three used by the U.S. Navy at Cavite in the Philippines during the 1930's.

outfit using three 650 foot towers must have been a heavyweight operation.

Inasmuch as the person who took the photo pointed out the U.S. Marine Barracks, perhaps we can assume that he was not only an American but also a member of the USMC or the Navy. Since there doesn't seem to be any radio towers shown on the island itself, can we take a stab and say that the station shown in the photo is one operated by the U.S. Navy, either NLB at Los Banos, Cavite or station NPO at Cavite? Listings of 1931 indicate NPO operated on 56, 8872, and 17744 kHz. We'll stick with our specu-

lation that the towers are those of NPO unless a reader can come up with anything more definite.

### Austrian Mystery

From a reader in Minnesota who asks that we refer to him as "Alex," we have a photographic postcard of a large and magnificent broadcasting station described only as "Bisamberg Sender." An Austrian postage stamp on the face of the card is cancelled with the date April 26, 1933. The reverse of the card is blank except for the name of its manufacturer in Austria.

We can't seem to root out any information

on this station and Bisamberg doesn't even show up on any maps of Austria. And yet this hilltop station appears most formidable.

If any readers can come up with additional information on this station, we'll be happy to share it with everybody else.

### Interesting Curio

We came across an interesting aluminum token about the size of a 50-cent coin. On one side is a depiction of a building and transmitting antenna along with the inscription "WJBK Radio-TV, Detroit, Michigan." On the reverse it reads, "Storer Broadcasting Company, New Center Studio Dedication, September 18, 1956."

Detroit area readers will quickly recognize WJBK-TV as being on TV Channel 2. WJBK radio went on the air in 1928 with 50 watts on 1370 kHz but by 1936 it had 100 watts on 1500 kHz. By 1946 WJBK had moved to 1490 kHz with 250 watts, however, by the 1960's it was back on 1500 kHz with 50 kW days and 5 kW at night, also FM on 93.1 MHz.

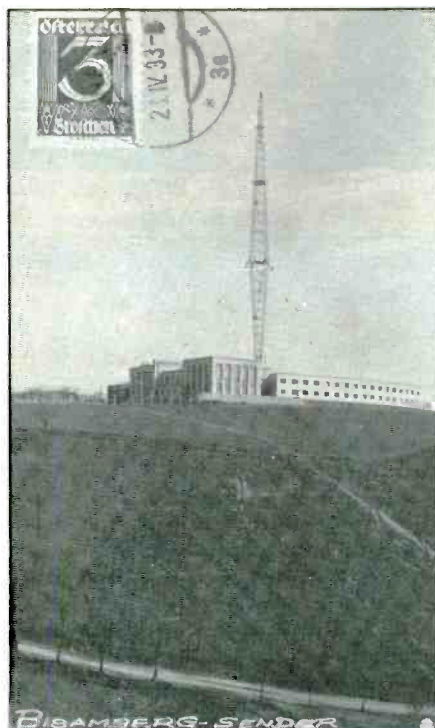

The "Bisamberg Sender" station, a 1933 mystery.



Commemorative medallion from Detroit's WJBK. It's from 1956!



Currently, what was once known as WJBK (AM) is now WLQV on 1500 kHz, while Detroit's FM outlet on 93.1 MHz is presently called WDRQ and the callsign WJBK is used only on TV.

Our shiny medallion appears to have been made up to commemorate the opening of the station's new offices 29 years ago.

### Tall Tale

Several times in the past we have run postcards showing photos of broadcast antennas described as being "the tallest." Here's another one. This time it's the "tallest radio tower in Alabama," that being owned by station WTBF in Troy.

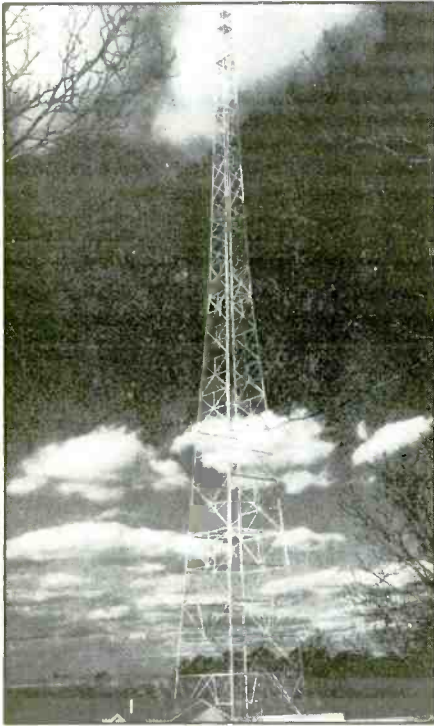

WTBF's tallest tower in Alabama.

Although the card is undated and no specific height is mentioned on the postcard, WTBF operates on 970 kHz with 5 kW days, 500 watts at night. Offhand, we would guess the WTBF tower to be about 200 feet in height.

Not to be outdone, another postcard from station KWTV (TV Channel 9) in Oklahoma City simply states that, at 1572 feet, it is the "world's tallest man-made structure." Well, let's say that this claim was true, but only from November of 1954 to December of 1956 when the 1610 foot KSWS mast went up in Roswell, New Mexico. Unfortunately, the KSWS mast toppled over in a gale in 1960, but by then the KWTV height record could not be regained anyway because of the 1619 foot WGAN (Portland, Maine) mast which was completed in September of 1959. Nevertheless, when the KWTV tower was completed, it was cause for much celebration because it zapped the 14 year record held by the Empire State Building (1472 feet with TV antennas added in 1951).

Next comes WTMJ-TV (TV Channel 4) in



The KWTV tower held the world's record for two years!

Milwaukee, Wisconsin with a postcard showing their 1035 foot tower and the claim that it's the "tallest structure in Wisconsin."

### From Sunny California

We came across an early view of station KFAC in Los Angeles. Although our picture postcard isn't dated, it shows Wilshire Boulevard at a time during the 1930's. The KFAC towers can be seen at the left of the card and appear to be mounted atop the church. Actually they are mounted atop a building that is a dealership for Auburn and Cord automobiles. In fact the KFAC towers are marked with the word "AUBURN" in addition to the KFAC callsign.

Inasmuch as Auburn and Cord cars stopped being produced in 1937, we will have to figure this view from the 1933 to 1937 era.

When the Los Angeles Broadcasting Co. brought KFAC on the air, it was running 1 kW on 1300 kHz. When the big frequency shuffle took place in about 1940, KFAC was moved to 1330 kHz. In 1946 the station's offices were at 645 South Mariposa, with the transmitter at 3725 Chesapeake in Los Angeles. KFAC continues on 1330 kHz but

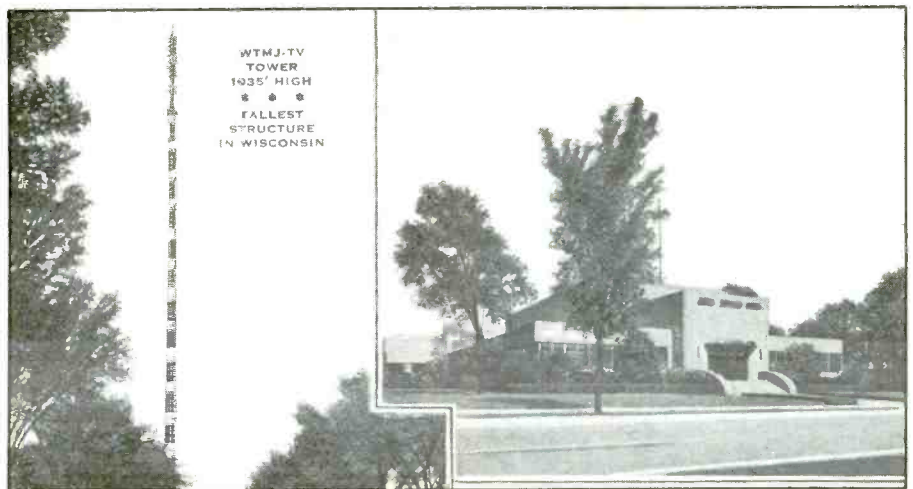

WTMJ-TV's tallest tower in Wisconsin.

The KFAC towers are at the left of the postcard view.





# Official Verification

from High Fidelity Broadcasting Station

# W6XAI

1000 WATTS . . . . . 193.5 METERS . . . . . 1550 KILOCYCLES

NAME Joseph L. Hueter DATE Feb. 4, 1936

This acknowledges as well as verifies your report of having received transmissions from this station on Jan. 29, 1936

Your co-operation and interest is appreciated by the entire staff.

OWNED AND OPERATED BY  
PIONEER MERCANTILE CO.  
BAKERSFIELD, CALIFORNIA  
Operators of Television Station  
W6XAH and Sound Station  
W6XE-2090 2100 KC

SIGNED [Signature]

STATION MANAGER.

W6XAI was an experimental broadcaster that became station KPMC in Bakersfield, California.

presently runs 5 kW. The present owner is KFAC, Inc. of New York City, New York.

## A Parting QSL

Courtesy of J.L. Hueter of Philadelphia, we can show you a QSL from experimental broadcaster W6XAI, 1550 kHz, of Bakersfield, California.

This exciting 1936 QSL was sent out by the Pioneer Mercantile Company to verify reception of their 1 kW high-fidelity station. The card also notes that Pioneer Mercantile

operated television station W6XAH and sound station W6XE, 2000 to 2100 Kc (kHz).

W6XAI eventually received a regular broadcast license as KPMC on 1560 kHz with 1 kW. KPMC continues on the air with 10 kW, still on 1560 kHz.

Another former experimental high fidelity station was W2XR in New York City, which is still on the air under the call WQXR. Like KPMC, WQXR uses 1560 kHz.

See you next month!

PC

## Historic Ham QSL's

UNITED STATES MARINES AT PUERTO CABEZAS, NICARAGUA  
IN SANDINO'S BACK YARD

Radio 8ADG Ur 40 MHz sigs

wkd here 13 JULY 23 OCT 1928

ART 1130 PM C.S.T.

QRM Some

QRN nil QSS nil

And R5-6 DC FB

# NN CAB

Transmitter IPTG So W.

Rec 2 steps and

Remarks here it is  
OT- wheres ur  
you sure ralf  
is here as just  
a great Rake  
out of our chat  
7/3 5

L. TALIR and F. M. BISSINGER  
(F P) (C R)

Operator SP

IX-64 COUNTRIES

What with the possibilities of American military deployment in Central America a topic of current discussion, here's a graphic reminder that this kind of talk has taken place before. This QSL card is headed "United States Marines at Puerto Cabezas, Nicaragua, In Sandino's Back Yard." The card is dated 23 July-23 October 1928, during the most recent American occupation of Nicaragua (it extended from 1926 to 1933). Actually, American forces have occupied Nicara-

gua several times during this century. Our QSL card was sent out by two Leathernecks who used the call signs NN and CAB while in Nicaragua. They operated on the 40 meter band with 50 watts.

Some of the other historic ham cards we have on tap are equally unusual and bear call signs such as EK1AZ, LI2JC, NB-BE3, X1AX, C2BE, XACP, EAR226, Y1CD, and CH2LD, among other delights. Watch for these!

# LISTEN UP!

Here's what you've been looking for—an all new hard-hitting monthly magazine which gives a unique insider's view of what's really going on in the world of communications. POP'COMM is your primary source of information—bigger and better than any communications magazine, with exciting coverage of scanners, shortwave broadcast & utility stations, spy stations, pirate and clandestine broadcasters, RTTY monitoring, survivalist communications systems, FCC news, wiretapping and bugging, scrambling/unscrambling, surveillance/undercover communications, satellite & cable TV, sophisticated telephones, & more. What you've been looking for all along! Take advantage of substantial savings over the newsstand price by subscribing now. Don't miss out on even one single issue of POPULAR COMMUNICATIONS—order your subscription now.

## Twelve Issues

# \$14

**POPULAR COMMUNICATIONS** 76 N Broadway, Hicksville, NY 11801

Yes! The NEW POPULAR COMMUNICATIONS is just the magazine I've been looking for. Start sending it to me now! I understand that I may cancel at any time for any reason, and receive a full refund on my unused subscription.

1 Year (12 issues) \$14.00  
Newsstand price \$23.40

2 Years (24 issues) \$25.00  
Newsstand price \$46.80

3 Years (36 issues) \$36.00  
Newsstand price \$70.20

Canada/Mexico — one year \$16.00, two years \$29.00, three years \$42.00 Foreign — one year \$18.00, two years \$33.00, three years \$48.00 Foreign Air Mail — one year \$71.00, two years \$139.00, three years \$207.00

Paid by:  Check  Money Order  MasterCard  Visa  
My account number is: \_\_\_\_\_

Name \_\_\_\_\_  
Street \_\_\_\_\_  
City \_\_\_\_\_ State \_\_\_\_\_ Zip \_\_\_\_\_

# BOOKS YOU'LL LIKE!

## Dial-A-Message

Want to know what the President has planned for today? Want to know how to apologize to someone? Want to know the best investments? Want to know your horoscope? Want a synopsis of your favorite soap opera? Looking for a job? Want to hear a tape recording about a specific medical problem? Want to know the latest sports, weather, or entertainment news? Special "hot line" telephone numbers across the nation have been established to provide virtually every type of information you could ever want, usually by means of recorded messages. A new 132-page book called *The Incredible Dial-A-Message Directory* lists more than 2,500 informative, entertaining, and often hilarious recorded messages from all areas of the United States.

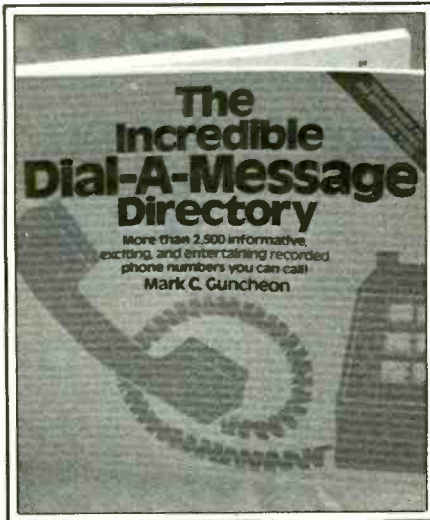

This book has everything from a Volcano Eruption Message (808-976-7977) and Dial-A-Quake (415-642-2160) to Dial-a-Dirty Joke (516-922-9463) and Dial-a-Gay Atheist (713-527-9255). WWF fans can hear Classy Fred Blassie swapping insults with Tom Kneitel's pal Capt. Lou Albano if they dial 212-976-6363. There's a hearing test played over 602-972-8762, and even a heartwarming inspirational religious message to be monitored by calling Dial-a-Moment of Sunshine at 316-321-3320. Depending upon where you're calling from, some of these calls may be charged at long distance toll rates.

This is just a small sampling of what this book has to offer, from the ridiculous to the genuinely useful. It was compiled by Mark C. Guncheon, who did lots of research. The book costs \$5.95, and if your local bookshop doesn't carry it, you can check on its availability by contacting the publisher, Contemporary Books Inc., 180 N. Michigan Ave., Chicago, IL 60601. Their phone number is 312-782-9181.

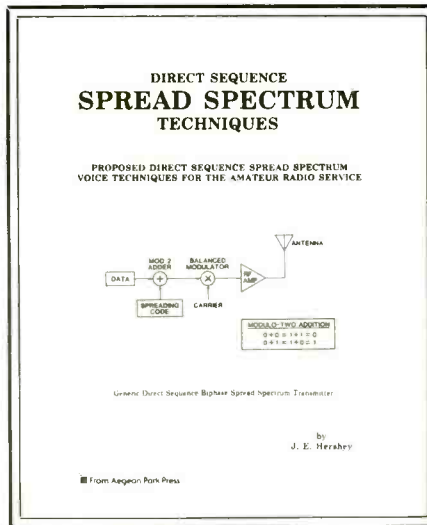

## Spread Spectrum

No communications technique has generated more of an aura of secrecy than has spread spectrum. Perhaps all of the mystery has been caused by its ability to offer communications where its signal is not always easily recognized nor easily detected. The two most commonly encountered SS techniques are frequency hopping (FH) and direct sequence (DS). A new book entitled *Direct Sequence Spread Spectrum Techniques*, by J.E. Hershey, is actually the Dept. of Commerce's NTIS Report 82-111.

The book covers all technical and non-technical aspects of DS type SS, especially as it relates to the Amateur Radio Service. The 151 page large-format (8½" x 11") book sells for \$32.80 from Aegean Park Press, P.O. Box 2837, Laguna Hills, CA 92654.

## Canadian Broadcaster

Well known Canadian broadcaster (CFMQ-FM, Regina, Sask, 92.1 MHz) Johnny Sandison is a *POP'COMM* reader. Johnny is also an author! His book *Hi! I'm Johnny Sandison* is the story of his many years in communications and broadcasting.

Commencing in 1948 as a relief fire alarm operator, Johnny worked his way through a fascinating career in broadcasting. Johnny's broadcasting began in 1953 at CKRM, and after 30 years on the air he has become one of the most admired broadcasters in southern Saskatchewan. His book is a wonderful, lighthearted look inside what went on behind the scenes in Regina's broadcasting history, including the stars, political bigwigs, and other radio personalities he has encountered. The text is enhanced by more than 70 photographs.

A really fine book that we recommend highly. It is published by Bridgens Publica-

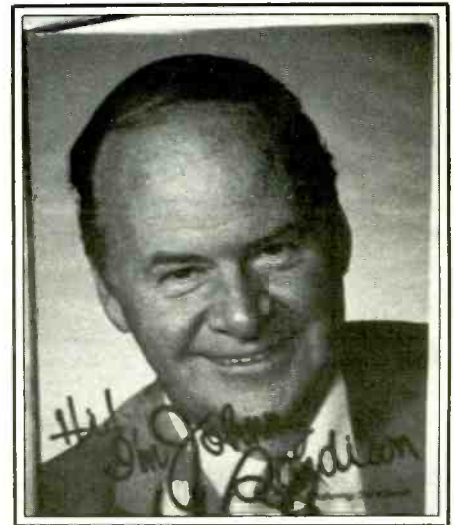

tions, 1150 8th Avenue, Regina, Sask., Canada S4R 1C9.

## Intelligence Warfare

A new book is available that reveals an enormous amount of information on the secret world of today's advanced espionage technology conflict between East and West. Chapters deal with the world's intelligence gathering organizations, spying, the electronic battlefield, plus extensive data on the role of espionage as it affects war in space as well as on land, sea, and air.

*Intelligence Warfare*, by Colonel William V. Kennedy, U.S. Army Reserve, is a magnificent 208-page hardcover book containing 208 large format (8½" x 11" pages), more than 100,000 words, over 80 maps, diagrams, charts and tables, plus more than 300 photographs (most in full color).

Of special interest to communications

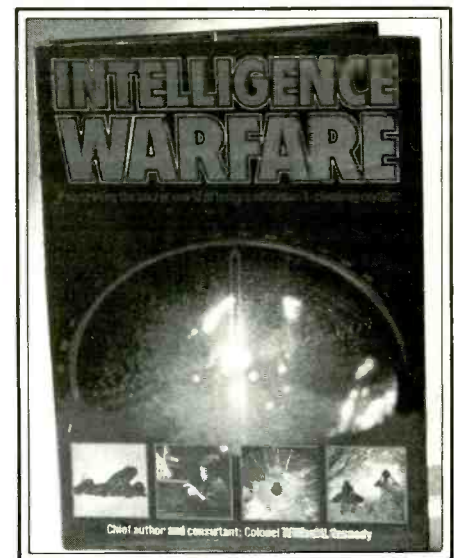



monitors is the book's in-depth study of electronics spying going back to 1916 and tracing it through to the latest techniques. It explains the different types of electronic warfare (EW), secret communications, jamming, countermeasures, miniaturized systems, locating enemy transmissions, new electro-optical systems, and much more.

This is a handsome volume that makes a great gift for anybody interested in shortwave and communications (including yourself). The book is priced at \$14.95, plus \$2 postage/handling to addresses in the USA/Canada/APO/FPO. It's available from CRB Research, P.O. Box 56, Commack, NY 11725.

### Where To Get That QSL

POP'COMM's own Gerry Dexter has just completed the 5th Edition of his guide entitled *World Broadcast Station Address Book*. This 128-page book is chock-full of the latest updated information for the QSL hunter.

The major ingredient of this useful directory is the highly detailed information on where to send your reception reports for best results. Addresses are given for shortwave and broadcast band stations throughout the world. In addition to the addresses, Gerry rates the stations to let you know which ones are good verifiers, which are so-so, and which are tough nuts to crack. He also provides the names of station personnel whose names appear on the QSL's.

# Address Book

There is information on how to prepare reception reports to get the best returns—and Gerry is the guy to dispense with this type of know-how inasmuch as he has collected 1,300 broadcast QSL's from 225 nations. His techniques have earned him a spectacular 90% return for his reports to stations!

The book also has photos of QSL cards from many stations, reporting codes, sample reception report forms, and more.

A worthwhile and handy guide for the DX fan now available at \$8.95 from our friends at Gilier Shortwave, 52 Park Avenue, Park Ridge, NJ 07656.

## MISSING

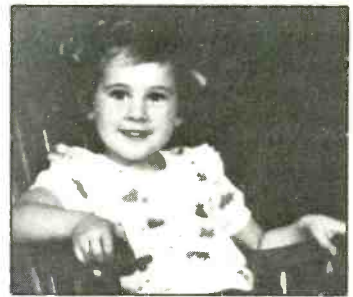

NAME: Leah Jane Guetier DOB: 5/30/79 Age: 6  
EYES: Brown HAIR: Brown DATE MISSING: 6/27/82  
FROM: Arlington, VA. CHILD FIND #1931P



NAME: Alton Malik Jett DOB: 2/12/73 AGE: 12  
EYES: Brown HAIR: Black DATE MISSING: 9/81  
FROM: Wayne, MI. CHILD FIND #2381P

If you can assist in identifying a child or if you are one of these missing children, call Child Find Inc., **TOLL FREE HOTLINE (800)-1-AM-LOST (914-255-1848 collect in NY). Please refer to the Child Find # when calling.**

Call us FREE **1-800-626-6343**

or write for FREE Flyer.

## COPPER ELECTRONICS

4200 PRODUCE ROAD - LOUISVILLE, KENTUCKY 40218



77-104

Retail \$84.95

**\$34.95**



79-260

Retail \$219.95

**\$119.95**



76-300

Retail \$149.95

**\$79.95**



Retail \$229.95

**\$129.95**



ASTATIC

T-UG9-D104

Retail \$84.95

**\$39.95**

MOBILE MOONRAKER  
AV-261M

Retail \$79.95

**\$39.95**

MOBILE MOONRAKER  
AV-261

Retail \$69.95

**\$26.95**

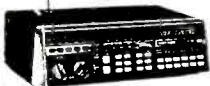

Beacat 300

Retail \$599.95

**\$329.95**



AV-261T

Retail \$69.95

**\$26.95**

### THE LOWEST PRICES IN THE COUNTRY!

Call for latest price quotes on all merchandise.

We have a national factory warranty service on many brands, and we service All CB, Amateur, and Commercial Equipment.

## NEW LISTENING ADVENTURES



### HEAR MORE THAN EVER BEFORE WITH THE NEW M-600A MULTI-MODE DECODER

Simple connections to your shortwave receiver and video monitor or printer will let you monitor thousands of Morse and Radioteletype signals in Marine, Commercial, Government, Military and Press Services. Converts standard CW and RTTY plus low and high speed ASCII, non-standard shift RTTY, Bit-Inverted RTTY and TOR (Telex Over Radio -FEC & ARQ). Isolated loop MIL-188 or RS232 provided; optional parallel printer port available.

### CONTACT US FOR DETAILED INFORMATION

Phone: 614 866-4267

MC & VISA Accepted

## UNIVERSAL SHORTWAVE RADIO

1280 Aida Drive, Reynoldsburg, Ohio 43068

CIRCLE 64 ON READER SERVICE CARD

# Low Band Military Aero Scanning

## *The VHF "Low Band" Still Has Mysteries To Reveal!*

BY RICK MASLAU, KNY2GL

**T**he military forces have moved their aeronautical communications to the esoteric 225 to 400 MHz UHF band, right? Well, yes, but many scanner enthusiasts don't (yet) seem to realize that *everything* didn't fly off to UHF-Land.

There's still quite a bit of military aeronautical traffic left to monitor right in the old out-of-vogue low band (30 to 50 MHz). These communications are mainly concerned with helicopter communications from Army Aviation and Army National Guard units, although there are also other units to be heard there. These units are often heard operating with practice drills or maneuvers, however, at times they do become involved in very real emergency situations such as search and rescue work, or functioning during forest fires or in the aftermath of violent weather. Army choppers played a vital rescue role in January of 1982 when Air Florida Flight 90 went into the Potomac River in Washington, DC.

A listing of many of the active low band military aero stations is shown here, and remember that even if you're not within ground range of these base stations, you can probably hear the choppers when they're airborne as their transmission range will be substantially increased. Aircraft flying at only 500 feet can be monitored for 30 miles, and as their altitude increases, so does their transmission range.

There are other military aeronautical stations not included in our listing, and you may wish to spot check certain frequencies known to be popular with these stations to see how many you can discover. And don't forget that when band conditions are right, that is, open for *skip* reception, you may be able to hear stations hundreds or even thousands of miles away on the low band.

Some popular Army National Guard aeronautical frequencies include: 32.30, 32.50, 34.15, 34.40, 35.00, 36.00, 36.10, 36.50, 36.70, 36.80, 38.45, 38.70, 38.85, 40.10, 40.25, 40.30,



Army and Army National Guard 'copters still make heavy use of frequencies in the 30 to 50 MHz range. (U.S. Army photo)

40.90, 41.00, 41.60, 41.70, 41.90, 42.00, 49.00, 49.40, 49.70, 49.80, 49.90, and 49.95 MHz. Note that 41.00 MHz is especially popular.

While 30.10 MHz is often used at Army heliports for fire and crash purposes, the following frequencies are in use for control tower use: 32.10, 37.00, 38.90, 41.50, 41.80, and 46.70. Especially popular is 41.50 MHz, with 40.50 MHz used as an emergency channel.

Range control stations often operate on: 30.45, 32.70, 34.20, 34.29, 34.30, 34.45, 34.50, 34.70, 36.10, 36.33, 36.75, 38.30, 38.50, 38.90, 40.45, and 40.60 MHz.

During practice drills and maneuvers it maybe worth checking out the following frequencies sometimes used for tactical purposes: 30.09, 34.00, 34.10, 36.45, 38.40,



While 41.50 MHz is a popular Army control tower frequency, other frequencies in this range are also utilized. (U.S. Army photo)



## Selected Low Band Military Stations

AL BIRMINGHAM MUNIC AIRPORT	38.70	MHZ	ARMY GUARD	MS C D LEMONS MUNIC APT, TOPELO	49.85	ARMY GUARD
AL BROOKLEY AIRPORT, MOBILE	36.80		ARMY GUARD	MT HELENA REGIONAL APT	40.65	ARMY GUARD
AL DANNELLY FIELD, MONTGOMERY	40.30		ARMY GUARD	NC BOGUE USMC, NEWPORT	48.70	OPERATIONS "BOGUE 03"
AZ SIERRA VISTA MUNIC APT	41.50		ARMY AVIATION	NC CHERRY POINT USMC	30.45	CONTROL TWR (EMERG)
AZ YUMA PROVING GROUND	41.50		CONTROL TOWER	NC CAMP MACKALL	38.90	RANGE CONTROL
CA CAMP PENDLETON USMC	41.95		CONTROL TWR (EMERG)		41.75	CONTROL TOWER
CA CAMP ROBERTS	38.90		RANGE CONTROL		41.95	CONTROL TWR (EMERG)
	41.50		OPERATIONS	NC NEW RIVER USMC AIR STATION	41.95	ARMY GUARD
CA FT IRWIN	38.90		RANGE CONTROL	NC RALEIGH-DURHAM APT	49.95	ARMY GUARD
	41.50		OPERATIONS	NC ROWAN CO APT, SALISBURY	49.95	ARMY GUARD
CA FT ORD	41.50		ARMY AVIATION	ND BISMARCK MUNIC APT	49.80	ARMY GUARD
CA HAMILTON FLD, SAN RAFAEL	34.50		ARMY AVIATION "MARATHON MARKER"	NE LINCOLN MUNIC APT	38.50	ARMY GUARD
CA LOS ALAMITOS	41.50		ARMY RESERVE	NH CONCORD MUNIC APT	46.65	ARMY GUARD
	65.05		ARMY GUARD	NJ MC GUIRE AFB	41.30	ARMY AVIATION
CA MATHER AFB, SACRAMENTO	41.00		ARMY GUARD	NJ MERCER CO APT, TRENTON	41.00	ARMY GUARD
CA STOCKTON METRO APT	49.00		ARMY GUARD	NV RENO/STEAD APT	40.40	ARMY GUARD
CA TUSTIN USMC HELICOPTER STATION	41.95		USMC (EMERG ONLY)	NY ALBANY CO APT, ALBANY	41.00	ARMY GUARD
CA TWENTYNINE PALMS USMC	41.70		GROUND CONTROL	NY FT DRUM, WATERTOWN	49.90	CONTROL TOWER
CO BUTTS AAF, FT CARSON	44.10		WEATHER	NY LONG ISLAND MACARTHUR APT, ISLIP	41.00	ARMY GUARD "LONG ISLAND GUARD"
CT BRADLEY INT'L APT, WINDSOR LOCKS	41.90		ARMY GUARD "FURY OPS"	NY NIAGARA FALLS INT'L APT	41.00	ARMY GUARD
CT GROTON-NEW LONDON APT	40.90		ARMY GUARD	NY STEWART APT, NEWBURGH	49.75	ARMY AVIATION
DE GREATER WILMINGTON APT	46.90		ARMY GUARD		38.20	ARMY RESERVE "CRISPY CHARIOT"
FL CRAIG MUNIC APT	40.90		ARMY GUARD		40.10	ARMY RESERVE
FL ORLANDO INT'L APT	46.60		ARMY RESERVE	OH AKRON-CANTON REGN'L APT	46.75	ARMY GUARD
GA BUSH FIELD, AUGUSTA	32.50		ARMY MEDEVAC	OH LORAIN CO REGN'L APT, ELYRIA	38.10	ARMY RESERVE
	46.70		ARMY AVIATION	OH OHIO STATE UNIV, COLUMBUS	46.80	ARMY GUARD
GA DOBBINS AFB, ATLANTA	47.00		ARMY GUARD	OH PORT COLUMBUS INT'L APT	38.10	ARMY RESERVE
GA FT BENNING	36.70		CONTROL TOWER	OH SPRINGFIELD-BECKLEY MUNIC APT	34.15	AIR GUARD "WOLF CUB"
	41.50		CONTROL TOWER	OK TULSA INT'L APT	46.90	AIR GUARD "LUNAR OPS"
GA FT STEWART	38.50		CONTROL TOWER	OR MC NARY FIELD, SALEM	40.90	AIR GUARD
	38.70		OPERATIONS	PA FT INDIANTOWN GAP	40.90	GROUND CONTROL
	41.30		ARMY AVIATION "VICTORY RADIO"		40.95	ARMY GUARD
	48.50		ARMY AVIATION "VICTORY RADIO"	PA GREATER PITTSBURGH INT'L APT	36.35	AIR GUARD "STEEL"
GA HUNTER AAF, SAVANNAH	46.70		CONTROL TOWER	PA WILLOW GROVE NAVAL AIR STATION	46.85	AIR GUARD
GA WINDER AIRPORT	34.00		ARMY GUARD	R1 QUONSET STATE APT, N KINGSTOWN	49.70	ARMY GUARD "FIERCE ALPINE"
IA BOONE MUNIC APT	40.60		ARMY GUARD	SC COLUMBIA METRO APT	38.10	ARMY AVIATION
IA DAVENPORT MUNIC APT	40.60		ARMY GUARD	SC MC ENTIRE ANG BASE, COLUMBIA	41.30	ARMY GUARD
IA DES MOINES INT'L APT	41.45		AIR GUARD	SD JOE FOSS FLD, SIOUX FALLS	36.85	AIR GUARD "CLARENCE 49"
IA WATERLOO MUNIC APT	40.60		ARMY GUARD	SD RAPID CITY REGN'L APT	41.50	ARMY GUARD
ID BOISE AIR TERMINAL	41.50		ARMY GUARD		34.40	OPERATIONS "SABRE OPS"
IL CHICAGO MIDWAY APT	47.00		ARMY GUARD	TN FT CAMPBELL	34.80	CONTROL TOWER
IL GREATER PEORIA APT	34.15		AIR GUARD		40.85	GROUND CONTROL
IL SCOTT AFB, BELLVILLE	46.60		ARMY RESERVE	TN MC GHEE TYSON APT, KNOXVILLE	49.80	ARMY GUARD
IN INDIANAPOLIS BROOKSIDE AIRPARK	34.70		ARMY RESERVE	TN SMYRNA APT	49.80	ARMY GUARD
IN SHELBYVILLE MUNIC APT	41.50		ARMY GUARD	TX ELLINGTON AFB, HOUSTON	41.00	ARMY GUARD
KS BEECH FACTORY, WICHITA	38.90		CONTROL TOWER	TX FT BLISS	36.70	CONTROL TOWER
KS FORBES FIELD, TOPEKA	41.70		ARMY GUARD		34.50	DISPATCHER
KS FT LEAVENWORTH	41.50		CONTROL TOWER	TX DALLAS NAVAL AIR STATION	34.70	ARMY RESERVE
KS FT REILY	30.30		OPERATIONS		46.80	ARMY GUARD
	41.50		CONTROL TOWER	TX FT HOOD	32.10	CONTROL TOWER "GRAY TOWER"
KY CAPITAL CITY APT, FRANKFORT	36.20		ARMY GUARD		38.70	DISPATCHER
KY FT CAMPBELL	33.20		WEATHER		30.45	RANGE CONTROL
LA ACADIANA REGN'L APT, NEW IBERIA	41.50		ARMY RESERVE		38.30	RANGE CONTROL
LA FT POLK	40.35		WEATHER	TX ROBT J MILLER MUNIC APT, AUSTIN	36.80	ARMY GUARD
	41.30		OPERATIONS "POE OPS"	UT SALT LAKE CITY INT'L APT	48.45	ARMY RESERVE
	41.50		CONTROL TOWER	VA CAMP A P HILL	38.50	RANGE CONTROL
MA FT DEVENS, AYER	46.95		OPERATIONS "MOORE OPS"	VA FT BELVOIR	52.75	ARMY GUARD
	49.90		ARMY RESERVE "PILGRIM OPS"	VA FT PICKETT	38.30	OPERATIONS
MA OTIS ANG BASE, FALMOUTH	51.15		ARMY GUARD	VA FT EUSTIS	38.40	OPERATIONS
MA WESTOVER AFB, CHICOPEE	38.70		ARMY GUARD	VA QUANTICO USMC AIR STATION	41.95	CONTROL TOWER
ME BANGOR INT'L APT	41.20		ARMY GUARD	VA R E BYRD INT'L APT, RICHMOND	40.40	ARMY GUARD
MI ABRAMS MUNIC APT., GRAND LEDGE	41.85		ARMY GUARD	VT BURLINGTON INT'L APT	46.90	ARMY GUARD
MI CAMP GRAYLING	37.00		CONTROL TOWER	WA FT LEWIS, TACOMA	34.60	VIP AIRCRAFT "BULLSEYE RADIO"
	41.80		RANGE CONTROL		41.50	CONTROL TOWER
	41.90		OPERATIONS		32.30	OPERATIONS
MN CAMP RILEY	49.20		CONTROL TOWER		38.90	WEATHER
	36.10		RANGE CONTROL	WA SNOHOMISH CO APT, EVERETT	46.70	ARMY RESERVE
MN ST PAUL DOWNTOWN APT	49.65		ARMY GUARD	WI DANE CO REGN'L APT, MADISON	40.80	ARMY GUARD
	41.50		ARMY RESERVE	WI FT MC COY	38.50	CONTROL TOWER
MO JEFFERSON CITY MEM APT	46.70		ARMY GUARD		41.70	CONTROL TOWER
	41.95		CONTROL TOWER	WI CAMP DOUGLAS	34.20	RANGE CONTROL "HARDWOOD RANGE"
MO SPRINGFIELD REGN'L APT	38.45		ARMY GUARD "SHOW ME ZULU"	WI WEST BEND MUNIC APT	40.80	ARMY GUARD
MO WHITEMAN AFB, KNOB NOSTER	41.00		ARMY GUARD		41.60	ARMY GUARD

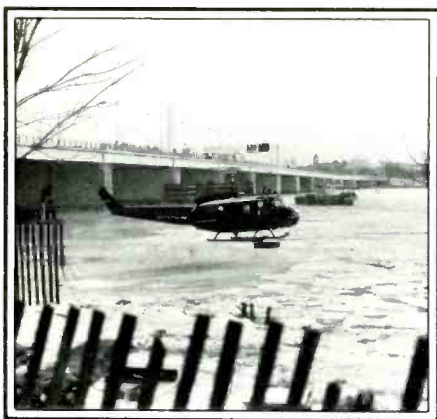

Army choppers play a vital part in emergencies, such as this daring mission over the icy Potomac River in January of '82. (U.S. Army photo)



Chopper communications during maneuvers can sound as dramatic as actual combat commos. (U.S. Army photo)

40.55, and 40.99. Note that these frequencies would also be used during actual emergencies.

In general, the following "low band" frequency segments are set aside for use by various federal agencies, including the military: 30.00 to 30.51, 32.00 to 33.00, 34.00 to 35.00, 36.00 to 37.00, 38.00 to 39.00, 40.00 to 42.00, 46.60 to 47.00, and 49.66 to 50 MHz. Some exploration of these frequency ranges will undoubtedly turn up all manner of interesting stations. Tom Kneitel's book, *Top Secret Registry of U.S. Government Radio Frequencies*, is a good reference guide to exploring federal communications between 30 MHz and the UHF bands.

Our chart, by the way, also lists some of the tactical identifiers used in place of standard callsigns by the stations listed. **PC**

# SCANNER SCENE

BY CHUCK GYSI, N2DUP

## MONITORING THE 30 TO 900 MHz "ACTION" BANDS

**L**ess than a few short years after Philadelphia's anti-scanner law was declared unenforceable, the state of Pennsylvania has taken moves to outlaw the use of mobile scanners.

A bill was introduced in the Pennsylvania Senate earlier this year and referred to the Transportation Committee in an effort to make it a crime to operate a scanner in motor vehicles. I'm not sure what the impetus was for creating such a law in Pennsylvania, but it's certainly a law that isn't needed.

The measure, designated Senate Bill 637, amends Title 75 of the Pennsylvania Consolidated Statutes governing motor vehicles and reads as follows:

**Title**—Operating a motor vehicle with radio capable of receiving police communications.

**General rule**—A person, except a police officer or peace officer acting pursuant to his special duties, shall not equip a motor vehicle with a radio receiving set capable of receiving signals on the frequencies allocated for police use, shall not knowingly use a motor vehicle so equipped or shall not in any way knowingly interfere with the transmission of radio messages by the police without first having secured a permit to do so from the person authorized by the local governing body of a city, borough, incorporated town, township or home rule municipality in which the person resides, or where the person resides in a county having a county police department, by the county commissioners of a county.

**Exception**—This section is not applicable to any person who holds a valid amateur radio operator's license issued by the Federal Communications Commission and who operates a licensed portable mobile transmitter and, in connection with a transmitter, a receiver or receiving set on frequencies exclusively allocated by the Federal Communications Commission to licensed radio amateurs.

**Penalty**—A person who violates this section commits a misdemeanor of the third degree and shall, upon conviction, be sentenced to pay a fine of not more than \$1,000 or to imprisonment for not more than six months, or both.

I personally find a lot of nit-picking problems with this proposed law. For instance, the two-way Regency programmable radio I use on UHF business and general mobile radio service channels is "capable" of receiving 460 MHz police channels. I guess that makes my two-way radio illegal.

How about all the firefighters who have scanners in their cars? Unless they all obtain



*This mobile phone control head manufactured by Antenna Specialists Co. allows 800 MHz trunked mobile radios to be utilized as mobile telephones through repeater interconnects.*

permits, their mobile scanners would be illegal. And suppose their police department dispatches them and they carry a pager on that frequency. Every time they get in their car wearing the pager, they would be breaking the law.

I'm on a roll: Every ambulance and fire truck in the state that has scanners installed to coordinate their responses with police departments would suddenly find their installations illegal without a permit. The exemption for ham radio operators is nice, but also lacking. It gives them the right to listen to amateur radio frequencies, but does not give them carte blanche to operate mobile scanners. Because many two-meter transceivers are capable of receiving outside the 144-148 MHz ham band, just the fact that the radio is capable of tuning in military police in the 138-144 or 148-150.8 MHz bands could make them illegal. The bill, also probably by no special design, could outlaw radar detectors because the microwave bands that are used for police radar are allocated for such use. I don't like to editorialize much in my column here, but this is one of the worst anti-scanner laws I have seen drafted.

The inherent matter here is that the bill would restrict the traditional rights of Americans to monitor the airwaves. The Communications Act of 1934 gives you the right to listen to anything you desire on the airwaves, as long as you don't reveal your intercepts to a third party or make monetary gains from the information overheard. There are many legitimate uses for scanners in addition to the examples I've cited. Many railroad enthusiasts, known as railfans, use

scanners to listen to railroad communications as an extension of their hobby. One large oil company in Philadelphia uses scanners to keep an ear on all the frequencies it is allocated. Townwatch units use scanners to coordinate their activities with police departments.

At the hearing in Philadelphia that effectively voided that city's anti-scanner law, I testified that it was possible to monitor police broadcasts on a TV set. I had been able to monitor the city's housing police on the 500 MHz band on my TV set and even had occasionally had interference from routine police communications in the 453 MHz band over the TV. Thus, if you outlaw scanners, should TV sets and FM radios be banned as well?

The All Ohio Scanner Club, which I thank for calling the bill to my attention, suggests that a national law be written that would outlaw the use of scanners during the commission of a crime. That's what all these anti-scanner laws attempt to do: keep the crooks from listening in. The All Ohio Scanner Club suggests that U.S. radio clubs or the American Radio Relay League, which represents amateurs, should set up the framework for getting such a national law passed. Such a law would pre-empt all these picayune state laws that patchwork the nation. I know it's a pain in the neck for me to have to check each state's scanner laws before I head out on a trip with the scanner in the car. I would wholeheartedly support the suggestion by the All Ohio Scanner Club. I'm more than willing to help get something going on this. If you're interested in helping create such a law on the congressional level, please drop me a line or send a note to the All Ohio Scanner Club in care of its president, Dave Marshall, at 50 Villa Road, Springfield, Ohio 45503-1036.

But that doesn't mean this law doesn't have to be defeated. I urge all of our readers in Pennsylvania to write letters to their individual state senators and state representatives in Harrisburg, PA. If you need the name and address of your legislators, the information usually can be obtained from your township building, borough hall, city hall, or municipal offices. Tell them why Senate Bill No. 637 stinks! I also lend my full support to rid us of this law and, if necessary, will meet with any legislators in the state capitol who would like to discuss the measure. If all of our Pennsylvania readers write or call their legislators, perhaps we can effectively kill the bill. Let me know what you think.

### **Columbus Fire**

This month, let's take a look at the system used by the Columbus Fire Department in Ohio, thanks to the All Ohio Scanner Club.



Columbus Fire Department		Station 2	South Fourth and Fulton E2, E3, L2, R2, M2, HM2, BC1	Station 22	Parsons and Southgate E22, L22
Channel 1	154.310 (153.770 is used as repeater input)	Station 8	Champion and Long E8, L8, S8	BATTALION 5—West	
Channel 2	154.310 simplex base and mobile	BATTALION 2—	Far North	Station 10	West Broad and Glenwood E10, L10, BC10
Channel 3	153.950 mobile	Station 6	Maple Canyon and Route 161 E6, S6, BC2	Station 12	Brinker and Sullivant E12, L12, S12
Channel 4	154.400 mobile	Station 11	Ohio State University airport (Don Scott Field) E11	Station 17	West Broad and Wheatland E17, R17, M17
Codes:		Station 19	North High at Northmoor E19	Station 26	Fisher and Phillpi E26
Emergency	Clear radio channel for transmission	Station 24	Morse and Karl E24, L24	BATTALION 6—Far East	
Code 1	Dead on arrival	Station 27	Smoky Row at Interstate 270 E27	Station 5	McNaughton between Broad and Main E5
Code 2	Send police on emergency	Station 29	Little Turtle at Route 161 E29	Station 20	Fifth and Dawson E20
Signal F	Working fire	BATTALION 3—	Short East, Short West and Short North	Station 21	Main east of James E21, S21, BC6
Signal L	Location	Station 7	Eighth and Indianola E7, S7, BA7, BC3	Station 23	Livingston and Hamilton E23, L23
Signal O	Indicates last unit is leaving the scene	Station 13	Arcadia and Demming E13, L13	Station 25	Port Columbus Airport E25 and Air Crash 1-6
Signal T	Time	Station 16	McGruffy and Weber E16, R16, M16	Station 28	McCuchon and Stelzer E28
Signal X	Stay in service	Station 18	Windsor and Cleveland E18, S18	TASK FORCE 1	E1, E9, L1, ES1, S1
Radio units:		BATTALION 4—	South	TASK FORCE 2	E2, E3, L2, M2, BC1, R2
Chief 1	Fire chief	Station 4	South Fourth and Lexington E4		
Chief 2	Executive officer	Station 14	Parsons and Hinman E14, S14, BC14		
ES 1	Assistant chief	Station 15	Livingston and Rhodes E15, L15, R15, M15		
ES 4	Fire alarm coordinator				
EMS 1	Emergency Medical Services battalion chief				
EMS 2	EMS captain				
EMS 3	EMS lieutenant				
Battalion 1-6	Battalion chiefs				
Fire districts:					
BATTALION 1—	Downtown				
Station 1	North Fourth and Mount Vernon E1, E9, L1, S1, ES1				

### Your Turn

As usual, we'd like to hear from you here at POP'COMM. Jot down your thoughts, frequencies, codes, or comments and send along any photographs you have of your shack or anything radio related to: Chuck Gysi, N2DUP, Scanner Scene, Popular Communications, 76 North Broadway, Hicksville, NY 11801-2909.

**★ QUALITY PARTS    ★ DISCOUNT PRICES    ★ FAST SHIPPING!**

**SEND FOR FREE FALL 1985 CATALOG... 48 PAGES!**

**ALL ELECTRONICS CORP.**  
905 S. VERMONT • P.O. BOX 20406 • LOS ANGELES, CA 90006

**13.8 VDC REGULATED POWER SUPPLY**

These are solid state, fully regulated 13.8 vdc power supplies. Both feature 100% solid state construction, fuse protection, and L.E.D. power indicator U.L. listed.

2 amp constant, 4 amp surge    \$18.00 each  
3 amp constant, 5 amp surge    \$25.00 each

<p><b>*SPECIAL PRICE* DUAL L.E.D. DISPLAYS</b></p> <p>560 high, 7 segment L.E.D. read-outs. Mount in 24 pin DIP sockets.</p> <p>FND-5148 red. c.c    75¢ each DL-527 red. c.a.    75¢ each MAN-6640 orange. c.c    75¢ each</p>	<p><b>EDGE CONNECTORS</b></p> <p>ALL ARE 1.56" SPACING.</p> <p>22/44 EDGE CONNECTOR PC style    \$2.00 each 22/44 EDGE CONNECTOR solder lug style    \$2.50 each 28/56 EDGE CONNECTOR PC style    \$2.50 each</p>
---	---

<p><b>MINIATURE TOGGLE SWITCHES</b> ALL ARE RATED 5 AMPS @ 125 VAC</p> <p>S.P.D.T. (on-on) PC style non-threaded bushing. 75¢ each 10 for \$7.00</p> <p>S.P.D.T. (on-on) Solder lug terminals. \$1.00 each 10 for \$9.00 100 for \$80.00</p> <p>S.P.D.T. (on-off-on) Solder lug terminals. \$1.00 each 10 for \$9.00 100 for \$80.00</p>	<p><b>D.P.S.T. LIGHTED ROCKER SWITCH</b></p> <p>115 vac lighted rocker snap mounts in 7/8" x 1 1/8" hole. Orange lens. 16 amp contact. \$1.50</p>
--	---

<p><b>ULTRA-MINIATURE 5 VDC RELAY</b></p> <p>Fujitsu # FBR211NED005M20 High sensitivity COIL: 120 ohms 10 for \$10.00 CONTACTS: 1 amp Mounts in 14 pin DIP socket</p>	<p><b>MINI-PUSH BUTTON</b></p> <p>S.P.S.T. momentary normally open 1/4" bushing Red button 35¢ each 10 for \$3.00</p>
---	---

**COMPUTER GRADE CAPACITORS**

2,000 mfd. 200 VDC 1 3/4" DIA. x 5" HIGH	\$2.00
3,600 mfd. 40 VDC 1 3/8" DIA. x 3 3/4" HIGH	\$1.00
6,400 mfd. 60 VDC 1 3/8" DIA. x 4 3/4" HIGH	\$2.50
9,700 mfd. 50 VDC 1 3/8" DIA. x 4 1/2" HIGH	\$3.00
31,000 mfd. 15 VDC 1 3/8" DIA. x 4" HIGH	\$2.50
72,000 mfd. 15 VDC 2" DIA. x 4 3/4" HIGH	\$3.50
185,000 mfd. 6 VDC 2 1/2" DIA. x 4 1/2" HIGH	\$1.50

**TOLL FREE ORDERS • 1-800-826-5432**  
(IN CA: 1-800-258-6666)  
INFO • (213) 380-8000  
TWX - 5101010163 ALL ELECTRONIC

- QUANTITIES LIMITED
- MINIMUM ORDER \$10.00
- USA \$3.00 SHIPPING
- NO C.O.D.
- FOREIGN ORDERS INCLUDE SUFFICIENT SHIPPING
- CALIF. RES. ADD 6.12%

CIRCLE 91 ON READER SERVICE CARD

**BUY THE BEST**

Replace Your Telescopic Whip With The Metz System. Metz Whips Plug Into Your External Antenna Connector. Right angle SO 239 supplied. For scanners, an adapter is supplied. Bracket supplied for outdoor mounting.

- Two Models: Scan 1 covers 30 MHz to 512 MHz SW 1 covers 50 kHz to 54 MHz
- All stainless steel—won't corrode
- Tuned coils offer 3 dB gain over telescopic whips
- Every coil tested and serialized
- No external power required
- Whip only 54" tall
- Antenna may be mounted mobile with accessory \$25.00 magnetic mount
- Lifetime Guarantee



**GORDON WEST, WB6NOA,** well-known radio expert gives Metz antennas his highest rating: "They equal the range of active antenna systems at one-third cost, and when you replace your telescopic whip with the Metz, you'll really hear the difference!" Metz stainless steel antennas are used worldwide by Mariners, Police, Business, and Commercial Radio users. It was the Ham Radio operators who discovered the phenomenal range increase when used on Ham worldwide and VHF equipment. \$59.95 from

**Metz Communication Corp.**  
corner Rt. 11 & 11C,  
Laconia, NH 03246  
Phone Orders Only:  
800-258-4680  
(Visa/MasterCard/C.O.D.)  
**Absolutely No Personal Checks**  
Technical Info: 603-528-259C

Shown mounted directly to receiver with supplied adapter. **Amateur antennas for 2 Meter & 440 MHz also available**

## ESTABLISHING SURVIVALIST COMMUNICATIONS SYSTEMS

### Well, Blow Me Down

**B**ased upon the large amount of reader mail this column has received in recent months asking for more information about emergency communication system antennas, I think this is a pretty good opportunity to offer some thoughts on the topic.

The main point is that while you may be safe and snug inside your radio operating "shack," your antenna system is outside in the thick of things and probably taking a lot of hard knocks. The antenna system has been gracefully aging all these months (or even years) in the baking sun, freezing cold and ice, soaking in the rain, and vibrating in the wind. Most folks think that they put it up to stay "forever." They never stop to think that it has been facing the ravages of weather, and consequently it may not be in the best of condition when it finally gets put to the test of some severe weather situation that comes barreling out of nowhere.

It does little good to have a well-equipped emergency radio system if the antennas are blown away with the first healthy gust of wind. My immediate observation here is that a great many antennas (from beams to ground planes) are simply not erected with sufficient stability to hold up as well as they might have with adequate installation. Folks are lazy; they just don't want to install guy wires on masts and other antenna supports. As a result, the masts are top heavy and therefore they become extremely unstable in high winds.

My suggestion is that any masting that extends more than 15 feet above a solid support (roof, chimney, etc.) be properly guyed in three or four directions, with additional guyed areas every 20 feet. Also take into account that the guy wires will have to be installed with insulators along the wires so that no individual section of any guy wire is resonant on the band you are using for transmission, otherwise your signal pattern will distort.

Also, even with a well-installed antenna, accidents and mishaps do occur. Antennas can come down with a thud no matter how well they are installed. Be prepared with emergency antennas kept in reserve so that they can be strung up if needed. These can be easy to make and can be stored in a minimum of space.

Furthermore, the materials and knowledge should be available to prepare (if all else fails) a "field expedient" emergency antenna system. If necessary, insulators can be fabricated from pieces of wood or rubber,

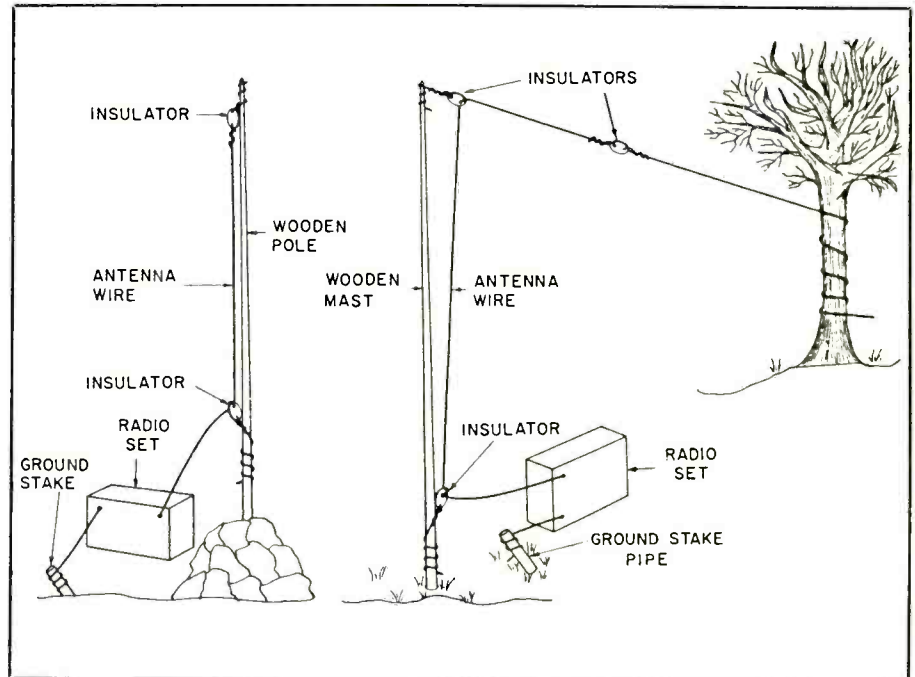

Field substitutes for vertical wire antennas.

Half-rhombic antenna.

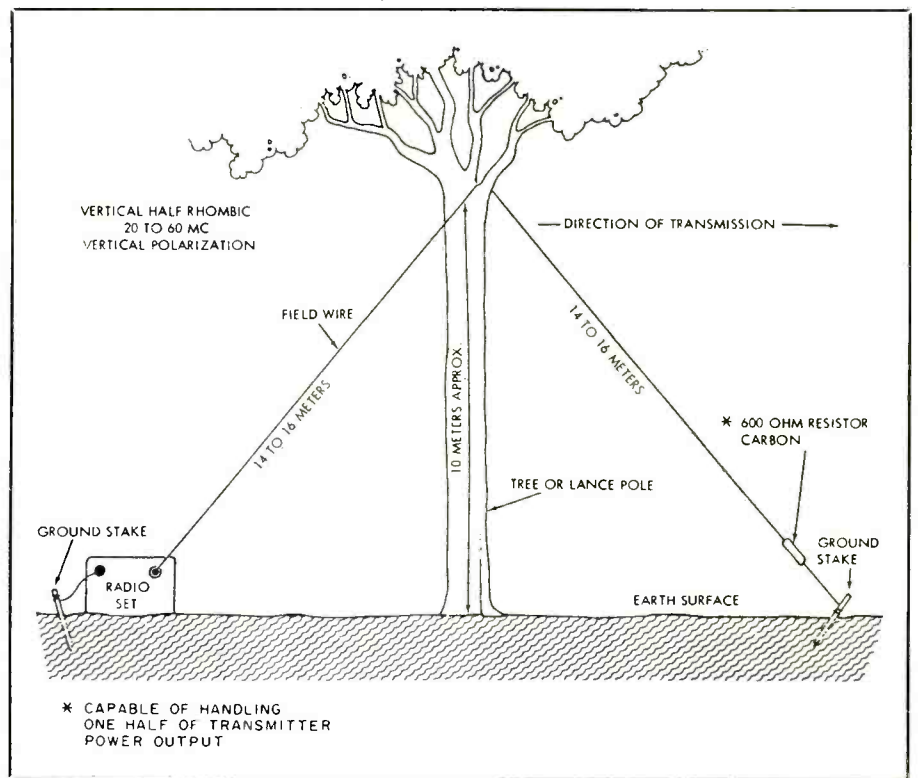



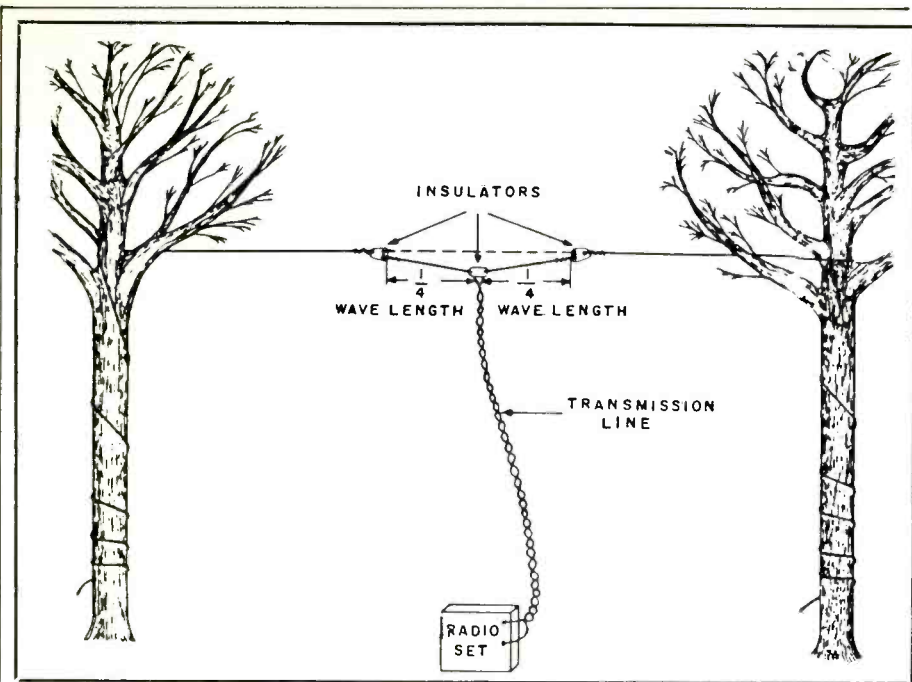

Improvised center-fed half-wave antenna.

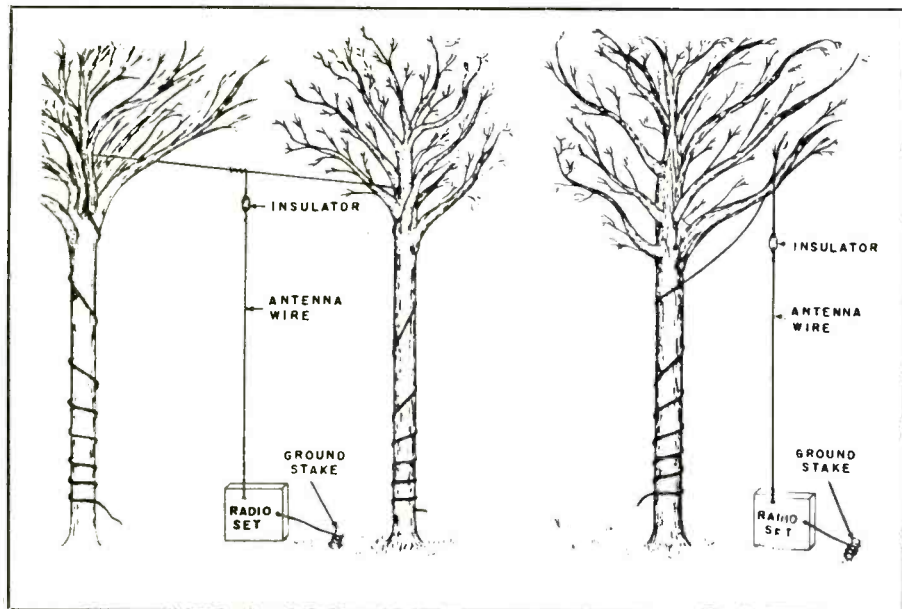

Additional means of supporting vertical wire antennas.

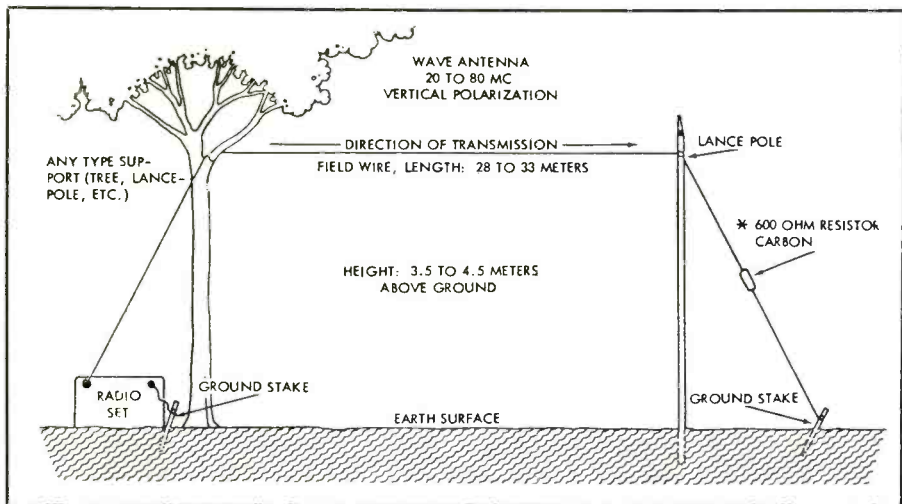

Wave antenna.

**SE** SIGNAL ENGINEERING's  
High Performance CB Antennas

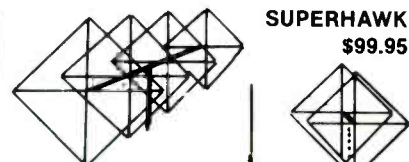

**SUPERHAWK**  
\$99.95

**WHITE LIGHTING**  
\$179.95

**DPX 2000A**  
\$124.95

**LIGHTNING 6**

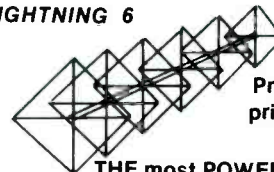

Promotional  
price \$329.95

**THE most POWERFUL  
CB base in the world today!**

All SE PATENTED rotary beams are true quads and OUTPERFORM their counter parts (quad/yagi types). SE's patented SFS matching system makes SE QUADS the most technologically advanced antennas in the world today. If your dealer doesn't have SIGNAL ENGINEERING, write or call for full specs. DEALER Inquiries Invited.

**SIGNAL ENGINEERING**

2624 Fayette Drive, Mountain View, CA 94040  
(415) 948-3833

**OUT NOW!**

**FREE**

**THE DICK SMITH ELECTRONIC ENTHUSIAST'S CATALOG**

132 PAGES CRAMMED WITH KITS, BOOKS, COMPONENTS, DATA, HAM GEAR AND MORE PLUS BONUS COUPONS WORTH \$2 REDEEMABLE OFF YOUR 1st ORDER

Rush me my copy of the Dick Smith Catalog, I enclose \$1 to cover shipping

Name .....

Address .....

City .....

Zip .....

DICK SMITH ELECTRONICS INC.  
P.O. Box 2249, Redwood City CA 94063  
Orders Toll Free 1-800-332-5373



# "INSIDER'S INFORMATION"

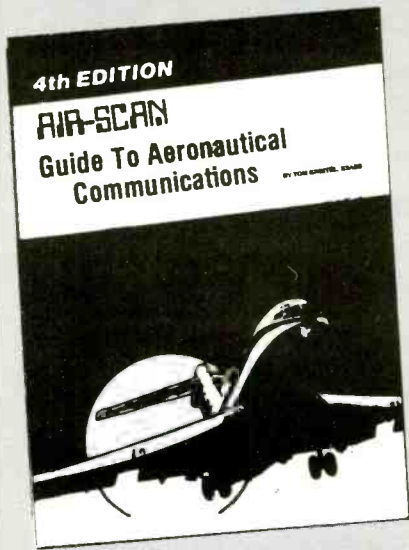

Since 1967, CRB Research has been the world's leading publisher and supplier of unique hobby and professional books and information including:

- Scanner Frequency Guides
- Shortwave Frequency Guides
- Military/Federal Communications
- Broadcast Station Registries
- Undercover Communications
- Survival Communications
- Covert Operations
- Electronic Espionage
- Surveillance
- Monitoring
- Cryptography & Codes
- Bugging
- Wiretapping
- Communications Antennas
- Electronics & Projects
- Authentic Combat Communications Cassettes
- Computer Technology
- & Other Related Topics!

New titles are constantly being added to our exciting catalog. If it's interesting and unusual, we've got it. You'll see! Ask for our latest FREE catalog!

**CRB RESEARCH**  
P.O. Box 56 Commack, NY 11725

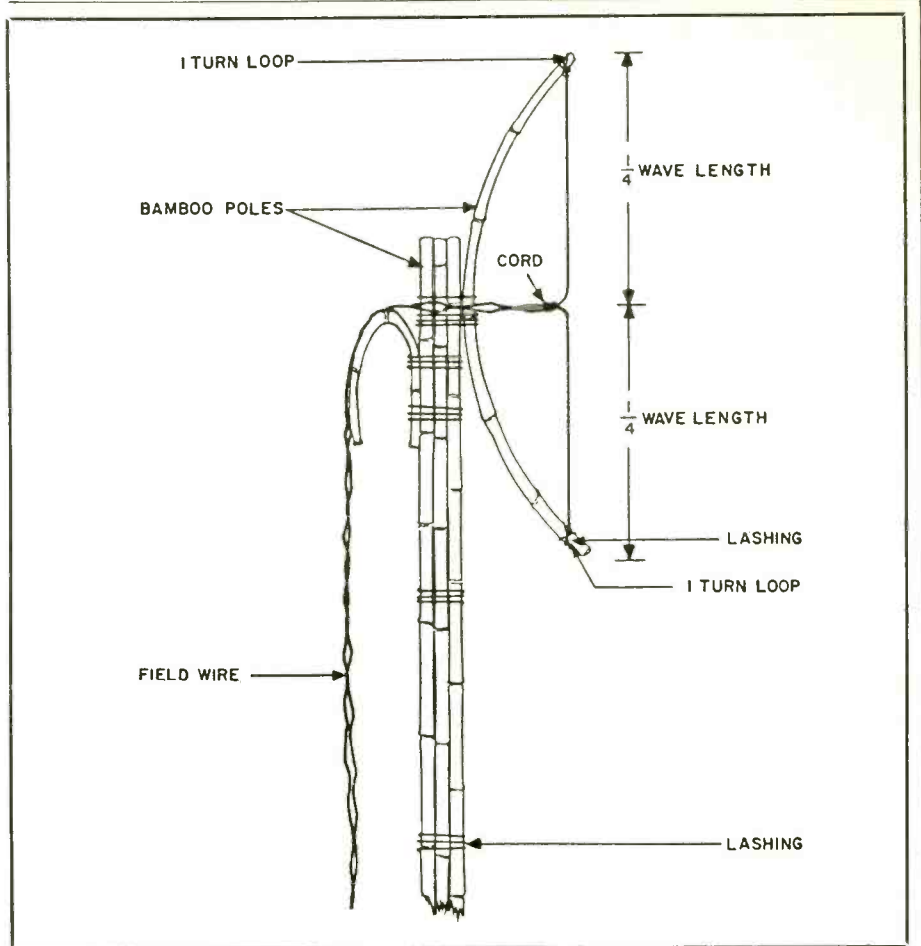

Means of supporting vertical half-wave antenna.

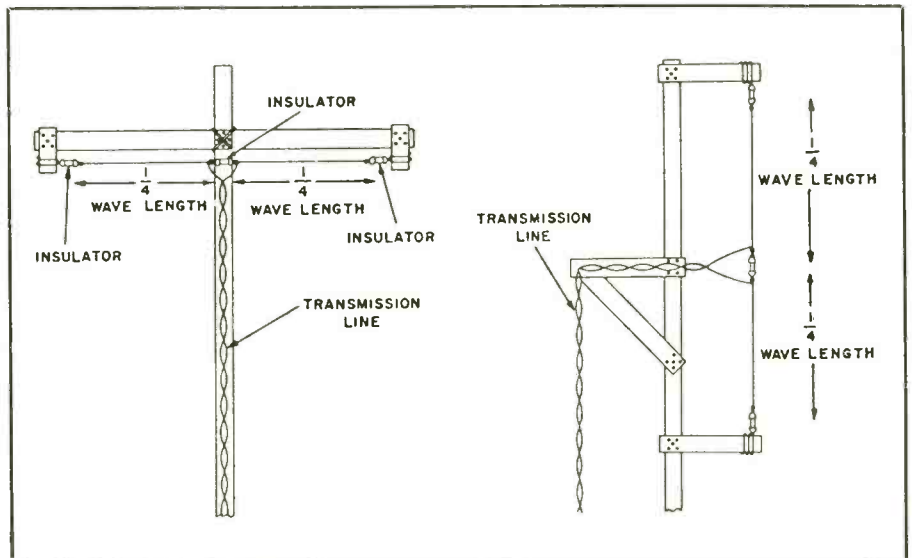

Elevated center-fed half-wave antenna.

antenna wire can be scrounged from 300 ohm TV twin lead, chicken wire, fencing wire, loudspeaker wire, picture hanging wire, or what have you. Guy wires can be rope or fishing line; masts can be fabricated from trees, bamboo poles, strips of wood bundled together, etc.

The designs for several field expedient antennas accompany this month's column.

The physical length (in feet) of a half-wave antenna may be calculated by dividing 468 by the frequency (in MHz). Thus if you are operating on 7 MHz, divide 468 by 7 and you come up with 66.8 feet, and there you have the length of an end-fed antenna. For center fed antennas, the wire on each side of the center insulator should be exactly half that length, 33.4 feet.

PC



# PRODUCTS

## REVIEW OF NEW AND INTERESTING PRODUCTS



### Level And Angle Indicator For TVRO Dish Installation

A magnetic level and angle indicator from Sylvax Corporation speeds the installation of TVRO dish antennas and assures the accuracy of both the angle of declination and the angle of elevation to 0.2 degrees.

Designed to set angles and/or measure them, the Inogon Level and Angle Indicator provides direct numerical readings of angles. It consists of an angle indicator calibrated in degrees that fits into a magnetized rule available in 10", 24", and 48" lengths. The

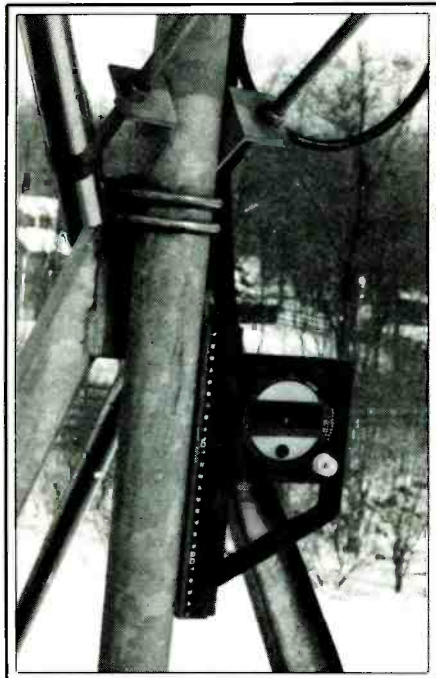

rule is calibrated in inches and centimeters. The indicator frame and window are made of high impact plastic.

The Inogon Level and Angle Indicator uses a new optical technology that eliminates errors in positioning the polar mount and the dish. Angle measurements are based upon a change in visual patterns that occurs when light passes through two superimposed optical windows.

To make sure that a polar mount is truly

plumb, an adjustment screw on the indicator is turned until 0 degrees on the moving scale lines up with a zero reference point on the fixed scale. Then the magnetic Level and Angle Indicator is attached to the pole and the pole is elevated into the position where parallel lines appear in the window of the angle indicator. At this point, the polar mount is vertical.

To set the angle of elevation of the dish, an adjustment screw on the indicator is turned until the desired angle of elevation (in number of degrees) on the moving scale lines up with a zero reference point on the fixed scale. The magnetic level and angle indicator is then attached to the crossbar of the "spider" (the supporting superstructure on the back of the antenna). The antenna is then tilted until parallel lines are seen in the window of the angle indicator, showing that the correct angle of elevation has been reached.

The magnetic Inogon Level and Angle Indicator is available from major distributors in the communications satellite industry. For additional information, write Dept. DA, Sylvax Corporation, 342 Madison Avenue, New York, NY 10017, or circle number 101 on the reader service card.

### Telephone Answering System Works With A Pager

The DuoFone® TAD-1280 Telephone Answering System With Remote Control is one of the first telephone answering machines that can work along with a separately purchased pocket pager. The telephone answering system's owner can be beeped anywhere within the pager's range to be alerted to telephone messages. The messages may be retrieved using the remote control unit.

If used without a pager, the system can pick up the telephone line once it receives a message, and dial up to three selected telephone numbers, including long-distance. Each number is dialed as many as five times, or until the line is answered. Again, a tone notifies the system owner that messages are waiting, and messages retrieved with the remote control unit.

This full-featured business answering system is designed to meet all the telephone answering needs of doctors, lawyers, and other professionals. Many businesses will find the need for an answering service eliminated by the new system's capabilities.

Remote control capabilities of the TAD-1280 telephone answering system include playback and reset, message erase, fast forward, rewind, record announcement, repeat remote playback, and a memo selector to record a reference message or instruction. Security coding of the remote control device ensures the privacy of the answering system.

Incoming calls may be screened by listening to the built-in speaker. Selected calls may be picked up, if desired.

The announce-only mode can be used to provide information to callers in situations where incoming messages are not appropriate. A CPC (calling party control) switch allows adjustment of the answering machine to meet the requirements of different area telephone systems. The CPC switch also allows the caller to leave a message of any length, turning the recorder off when the calling party hangs up.

The DuoFone TAD-1280 telephone answering system (cat. no. 36-1300) is available for \$349.95 through Radio Shack® Telephone Centers and participating dealers nationwide. **PC**



# RTTY

BY ROBERT MARGOLIS

## THE EXCITING WORLD OF RADIOTELETYPE MONITORING

**T**here are more than 500 news and information agencies in the Federal Republic of Germany, but only one uses RTTY over HF radio: Deutsche Presse-Agentur, the German News Agency, based in Hamburg. It is the largest of some 145 newsgathering agencies in West Germany.

DPA has a worldwide staff of 360 correspondents. A total of 120 work at the Hamburg central office and 180, including photographers, work elsewhere in the FRG. There are 60 foreign correspondents, of which six are in the United States along with four permanent stringers.

Dispatches from foreign correspondents are sent to Hamburg via satellite or submarine cable. A DPA correspondent working in Rio de Janeiro, Brazil, for instance, sends news copy via the Intelsat III satellite to New York City. The copy is then sent to London, England and Brussels, Belgium to Hamburg via a leased teleprinter line. A network of these lines, extending over hundreds of thousands of kilometers, cover the globe.

A computer at the Hamburg office receives and stores the news dispatches, which are then directed to various editorial desks such as the German national service and the services for Europe, Asia, Africa, and Latin America.

Also stored in the computer are news items monitored over shortwave radio or dictated over the telephone to a rewriter. Antennas on the roof of the Hamburg office receive and transmit news on HF radio frequencies.

Desk editors select and edit incoming stories which are flashed on video screens on their desks. News also may be written on the same video screens. Computer-processed news items are sent to another video screen, then through storage to the desk editor handling them. After that, a duty editor copyreads the stories on a video screen before the stories are sent to DPA's subscribers. Edited news then is transmitted around the world either by shortwave radio, submarine cable, or satellite.

DPA also relies upon obtaining news from 60 national and international news agencies, in a worldwide exchange system, for its German subscribers. Included are many Eastern block and Third World news agencies. Special relations are held with United Press International in the United States. UPI's international service is one source of news to DPA for events occurring outside West Germany. In exchange, UPI partly bases its coverage of West Germany on DPA material.

The European Service of DPA transmits about 25,000 words daily in German to the

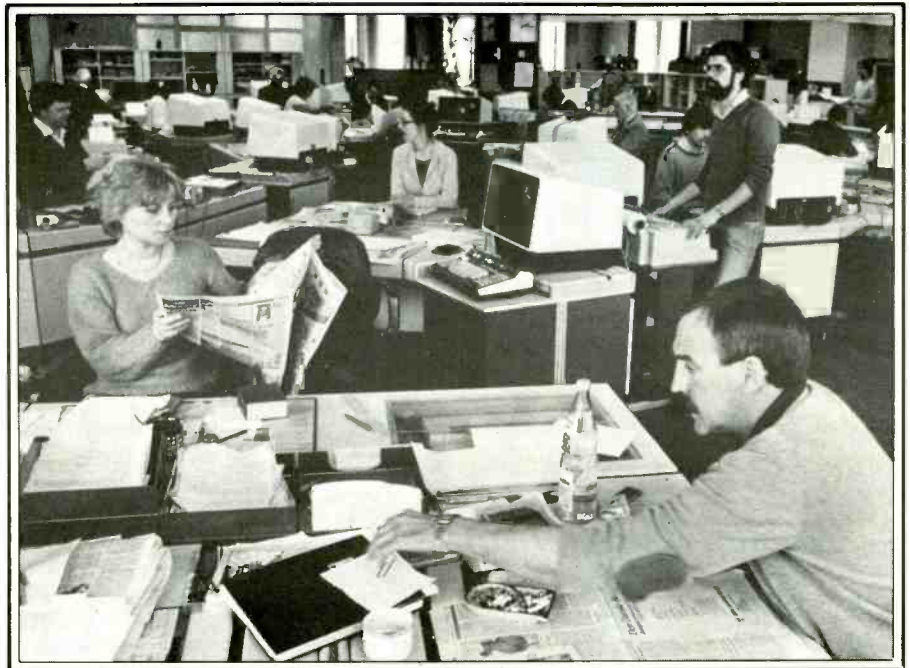

*The central newsroom of DPA's Hamburg headquarters.*

agency's European clients. Another 16,000 words in English are sent by DPA's International News Service; 15,000 words are sent by the Middle Eastern Service, which edits the news in Hamburg in English, then sends it to Cairo, Egypt for translation into Arabic; and 25,000 words in Spanish are sent by the Latin American Service.

Shortwave radio transmissions of DPA news are sent only to Africa and Asia. All newscasts are in English. Reception has been found on 13482 from 1600 to 1900 GMT; 15996 from 1500 to 1800 GMT; 18698 from 1000 to 1600 GMT; and 18701 from 0900 to 1800 GMT. RTTY setting is 450/66N.

The agency issues no QSL cards or letters, according to Gerd Rainer Neu, Chief of DPA's English News Service.

About 500 agencies, newspapers, publishing groups, and radio and television stations subscribe to DPA's foreign services.

Headquarters for DPA's photo service is in Frankfurt, West Germany. Staff photographers are stationed at the country's most important news centers. Photos for the German media also are obtained by DPA in an exchange contract with UPI.

DPA began its service in 1949 from the merger of three news agencies set up by France, Great Britain, and the United States when they occupied the country immediately following World War II. DPA's first news item was transmitted on September 1, 1949.

The news service is an independent agen-

cy. Its statutes say that it "shall carry out its allotted task impartially and independent of pressures and influences exercised by parties, ideological groups, economic and finance groups and governments."

It is owned by 188 shareholders, of which 162 shares, or 77.4 percent are held by newspaper publishers; 23 shares, or 11.4 percent, are held by periodicals and the trade press; and 3 shares, or 11.2 percent, are held by radio and television stations.

One owner of DPA stock, the Los Angeles Times-Washington Post News Service, is responsible for distributing DPA news in English and Spanish to the news media in North America. LAT-WP also has rights to DPA photos for use in the U.S. and Canada.

### **In The Mail**

Now for a look inside the RTTY mailbag. Jeff Ledger of Santa Rosa, California asks how to connect his Kenwood R-2000 receiver to his Macintosh computer to receive RTTY and CW.

The answer comes from a ham shop in the Chicago area. It is suggested that a Kantronics Universal Terminal Unit, or UTU for short, be used to connect the receiver to the computer. A salesman at the ham shop, which also sells Macintosh computers, says that a special cable will have to be made to connect the UTU with the RS232 serial port on the computer.

Suggested retail price of the UTU is \$199.95. Kantronics is at 1202 E. 23rd St.,



Lawrence, Kansas 66046. Write to them, Jeff, visit a ham shop in your area, or write to any of the dealers in ham gear that advertise in POP'COMM. In any of your inquiries, include the pin setting of your RS232 port, which you'll find in your owner's manual, so you can get an estimated cost of making the cable attachment.

Jeff also seeks the best book about RTTY for beginners. In print are: *RTTY Today: Modern Guide to Amateur Radioteletype*, by Dave Ingram—112 pages, Columbus, Ohio, Universal Electronics, 1984; and *Teletypewriter Handbook*, by A.G. Hobbs, E.W. Yeomanson, and A.C. Gee—Hertfordshire, England, Radio Society of Great Britain, 2nd ed., 1983. Ingram's book is good for those new to RTTY monitoring. The handbook is excellent but highly technical and recommended for owners of RTTY machines. Both may be found at ham shops.

Out of print are: *Beginners RTTY Handbook*, by RTTY Journal, 86 pages, Cardiff-by-the-Sea, California, RTTY Journal; *Specialized Communications Techniques for the Radio Amateur*, 208 pages, Newington, Connecticut, The American Radio Relay League, Inc., 1975; and *Principles of Telegraphy (Teletypewriter)* by the U.S. Department of the Navy, Washington, DC, U.S. Government Printing Office, 1967. RTTY Journal's handbook is highly recommended and still may be found in some ham shops. ARRL's book is somewhat dated but still useful. A public library may have this book as well as the U.S. Navy book, which is a bit technical but carries information about Frequency Division Multiplex and other RTTY systems encountered on the HF bands.

## Loggings

Opening the RTTY logbook this month, we find:

**3387:** NMN, USCG Portsmouth VA working NRUS (USCGC BISCAYNE BAY WTBG-104), also NRCX at 0125, 170/75R. (Tom Kneitel, NY)

**5072.2:** AP and UPI news being sent to AFRTS subscribers probably via NAM, U.S. Navy Radio, Norfolk, VA. Was 085/66R at 0155. This was an FDM transmission. (Fred Hetherington, Ormond Beach, FL)

**6504.5:** 3FWB2, New Vanguard, sailing to New Haven, CT, working WCC, Chatham Radio, MA, at 1729, ARQ. Working WCC at 1745 was JXWY, Wangli, a Norwegian offshore-loading tanker, and at 1813 it was HBDR, M/V Regina, a Swiss general dry cargo vessel. (Editor's logging)

**8115:** VMA, where?, sending foxes in 850/75R at 1138. (Kneitel, NY)

**9114:** MTI, Budapest, Hungary, with RY's, 425/66N, beamed at 1701 to Europe and North Africa. Transmission of news in English began at 1704. (Editor's logging)

**9290:** FUJ3, the French Navy facility at Noumea, New Caledonia, with naval messages in French at 1407 being sent to "RFHIC" and "FAAG." Was 850/100R. (Editor's logging)

**9909:** Unidentified U.S. meteo station running weather data at 2327, 350/66R. Takes were headed with "ZCZC WBC" and take numbers. WBC is usually found on copy from Miami Meteo Station, FL, which transmits at 850/100N. Any reader know for sure if this is from Miami or from another site? (Editor's logging)

**10019.3:** "W7F," location possibly in Peru, sending RY's to "Q4X," 850/66R, at 1210. Previous logging seems to indicate Peru Defense Forces stations. (Hetherington, FL)

**10245:** SOK224, Polis Press Agency, Warsaw, Poland, 425/50R at 0028 with RY tape. Announced parallel with SOI213 on 8133 kHz. (Kneitel, NY)

**11133:** "Tango Cinco Mike" with RY's and SG's to "Quebec Cuatro X-Ray" at 0402. Was 850/66N. (Editor's logging)

**11249:** 5KM, Bogota, Colombian Navy ("LA CINTA DE PRUEBA") 425/75R at 1231 with RY tape. (Kneitel, NY)

**12131.8:** Commercial messages in Spanish being sent by "GN," a Mexican government station at Ensenada, around 2300, 170/75N (57 baud). (Hetherington, FL)

**12222.3:** Venezuelan Defense station "BE-11" with traffic in Spanish to "CGA" at 2005, 850/66N. (Hetherington, FL)

**12484:** VKX, an unidentified station but possibly the East German embassy in Havana, Cuba, sending RY's plus "VKX VKS VKX 6/1716" at 1538, 425/66R. At 1539,

## ICOM R71-751-R7000\* COMPUTER INTERFACE



MICROCOMPUTER ELECTRONICS CORPORATION NOW OFFERS THE M.E.C. 71α COMPUTER CONTROL INTERFACE THAT WILL CONTROL AND EXPAND THE CAPABILITY OF THE ICOM R71A.

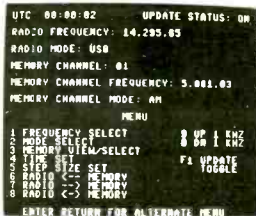

**MAIN MENU** Control center for entire system. Showing: 24HR UTC time; radio freq. & mode; memory CH, freq, mode plus ID functions for your selection.

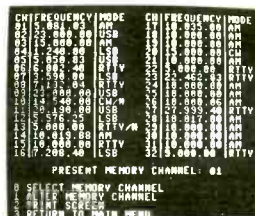

**32 CH RADIO MEMORY** Showing freq to 10 Hz, mode, filter w/n. Load/change any memory, mode, filter direct from keyboard and print command.



**AUXILIARY MEMORY** Showing page 1 of 47 pages each having 15 memories. Freq, mode, UTC time and room for your notes. Auto log feature allows instant logging of receiver freq, mode, time.

- **Easy to use.** No computer knowledge needed, automatic program loading. No disk or tape required (except for aux memory storage).
- **Menu driven** to aid user at each step.
- **No radio modification necessary** (ICOM EX309 — not supplied — required).
- **AUTO LOG** Allows logging of radio freq, mode and time by press of a key.
- **UNLIMITED STORAGE** via computer disk or tape (store 705 CH per disk side). Let your imagination run wild.
- **Software update.** As new software is developed MEC will make it available to owner subscribers.

- **HARD COPY** via computer printer of all memory channels.
- **KEYBOARD** memory loading.

Price to be announced - CALL. Available Fall 85. Dealer inquiries invited.

EEB is the exclusive distributor for Microcomputer Electronics Corp.'s product worldwide. Address all inquiries to EEB.

EEB is an authorized ICOM dealer and service center. Buy with confidence.

## GET ALL THE DETAILS. WRITE OR CALL EEB TODAY



- Prices & specs subject to change
- Shipping charges not included
- Returns subject to 20% restock charge
- Free catalog in USA; all others 3 IRC's

ORDER TOLL FREE 800-368-3270

Tech Info — VA orders 703-938-3350

**ELECTRONIC EQUIPMENT BANK**  
516 Mill Street NE  
Vienna, VA 22180 USA

CIRCLE 170 ON READER SERVICE CARD





# SATELLITE VIEW

INSIDE THE WORLD OF TVRO EARTH STATIONS

BY LANCE MCGRAW

## How The American TV Networks Got The Hostage News Home Pronto!

**T**he Makarios Earth Station played an important role with the recent hijack scenario in Beirut. When trouble began to intensify in the Middle East, the Lebanon Earth Station was shut down. Therefore, when the hoards of news people arrived in Cyprus, the Makarios station provided the link between Larnaca Airport and New York.

For the most part, three-man crews were sent into Beirut to cover the story. They consisted of a newsman, cameraman, and a soundman, and they primarily used the Iki-gami HL-79 camera. The video recorders were Sony's—either BVU-50's or BVU-100's  $\frac{3}{4}$ " helical (Slant Track) scan, each with their own good points. The BVU-50 is the lighter weight of the two machines and is easy to carry, but records-only. The BVU-100 does playback, but there is a compromise regarding the weight factor: when the soundman has to carry it for ten hours, that makes a difference in itself. The videotapes were all  $\frac{3}{4}$ " format and were 20-minute lengths. The microphones used by the soundmen were very directional, allowing pickup of the sound without getting that close to the source to record it.

Additional sources of information were provided by the English language broadcasts by the various factions on the following frequencies:

Lebanese Forces—1475 kHz at 0630, 1830, 1945 GMT

Philange Radio—873 kHz at 1100, 1500, 1900 GMT

Mirabi Sunni—927 kHz at 1500, 2000 GMT

Shiite State Radio—990 kHz at 1705 GMT

BBC World Service—1323 on the hour

The Standard broadcast band in the Middle East is divided up into 9 kHz segments instead of the 10 kHz segments used by the American broadcasters. The BBC was relayed from London via satellite and rebroadcast. The signal levels of all of the above-mentioned frequencies were excellent day or night in Cyprus and were not subject to the fading associated with the shortwave bands. There was also an amazing amount of signal jamming going on. It seems that a sound track to a *Pac Man* video game is used to modulate a standard AM carrier (and at more than 100%, I might add), splattering all over the place. The only problem with this method is that everything gets wiped out



except for a few of the super signals that seem to permeate the band.

When the news crew was finished in Beirut, a chartered aircraft was waiting to get them to Larnaca, Cyprus as quickly as possible. Since Cyprus was only 107 miles from the scene of the action, it was a logical base of operation, as it is politically neutral in the area. As soon as the news crew landed at Larnaca Airport, they rushed to a local hotel where a room had been set up to cut or edit all the tape into a finished news story. During this process, the pictures and the announcer's voice tracks were aligned so that the pictures and story agreed. Also, the story had to be cut down to a time period that could be managed and fit into a news

*The Mideast Airlines jet that brought the first American hostage, Jim Palmer, to Larnaca Airport. (This and all photos in this article are by Lance McGraw)*



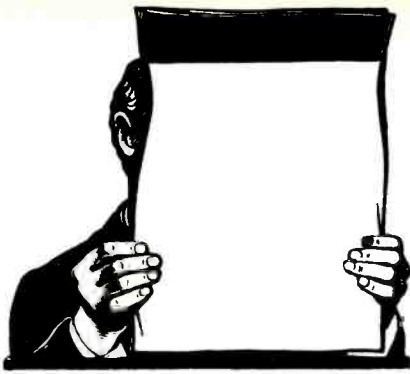

## The Clandestine Confidential Newsletter

A new publication devoted to clandestine stations and programs, *The Clandestine Confidential Newsletter* is designed to keep you up to date on this intriguing aspect of shortwave listening and DXing.

C-C-N will be published six times a year, beginning with the February, 1984 issue. It will contain the latest frequency and schedule information, monitoring data, background information, addresses, and features on new and old stations.

C-C-N will serve as a continuing updater to the new book *Clandestine Confidential*, being published by Universal Electronics.

Subscriptions to C-C-N are \$10.00 per year in North America, \$13.00 overseas, payable in cash, check or money order.

Also available: *List of Clandestines By Time* and *List of Clandestines By Frequency* for \$3.95 each.

To subscribe, send your remittance to:

C-C-N,  
Gerry L. Dexter,  
RR4 Box 110,  
Lake Geneva, WI 53147, U.S.A.

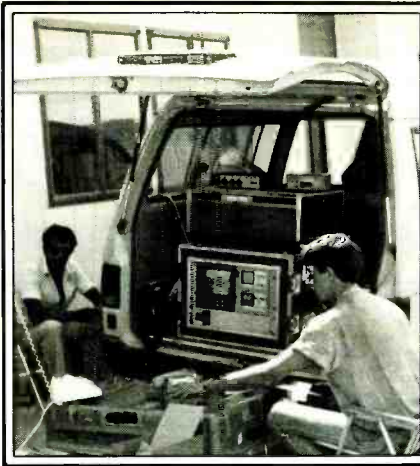

The CBS van at Larnaca Airport for coverage when the hostages were released. Since Larnaca was so close to Beirut, it was thought that it would be the hostage release point, but only one hostage arrived there.

broadcast, which meant two minutes or less.

The editing equipment for most of the U.S. television networks consisted of all Sony BVU-800 tape machines connected in two machine pairs for editing—one machine being the play and the other being the record. During this process the incoming tapes were logged so that proper picture information could be selected and the position on the tape could be identified. This position was marked electronically by a system called time code.

There is a special and isolated track on the video tape that records the time of day as well as the exact video frame, so that in the edit process, this position can be found quickly. The format of this time information has been standardized and can be used by any of the U.S. television networks equip-

*In addition to TV services, the BBC audio from London is also downlinked and sent via microwave to a local transmitter in Cyprus, where it is rebroadcast on 1323 kHz for Mediterranean area reception.*

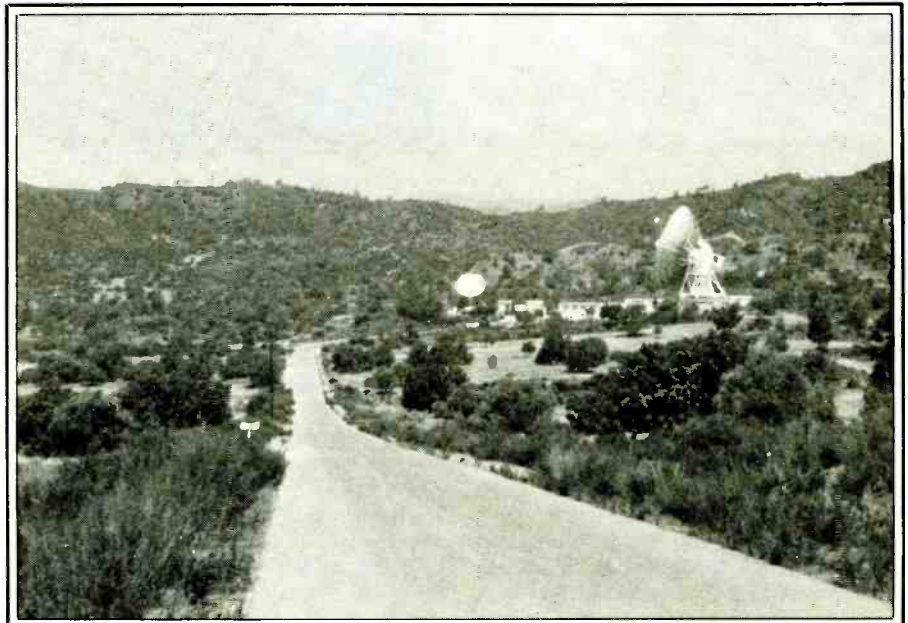

The Makarios Satellite Earth Station, on Cyprus, was a Class A Intelsat station that used a 30 meter dish with a forward gain of 62.84 dbm at 6 GHz. This station sent hostage-related TV coverage to the U.S. and Europe.

ment. When the edit process is complete, the finished story is timed and that information is called into New York so that room can be left in the nightly news.

The race was on to get to what was called the *feed point*, in this case located in the town of Nicosia. This was the home of Cyprus television and the microwave link to the Makarios ground station. While the distance was only 20 some odd miles, the trip by auto took the better part of an hour because of poor roads and traffic. The editors hand delivered the tape to the feed point because of familiarity with the piece and could balance the sound levels to their liking when it was transmitted to New York.

Once the editor had the videotape in the feed machine, a phone call was placed to New York to watch for the incoming feed via





This truck was rented from the Cyprus TV station and provided some broadcasters with a video/audio link from Larnaca to the Makarios station.



A new, small portable earth station used by NBC on Cyprus. This Ku-band (12 to 14 GHz) equipment was made by McMichael and airlifted to Cyprus. The receiving station was the Madley Earth Station in England (operated by British Telecom).



The Ku-band transportable earth station was flown in by a cargo aircraft called a Belfast (similar to a U.S. C-130). It was set up for full operation in less than 12 hours by its crew of three technicians.

satellite. For instance, in this case, the signal went from the television station in Nicosia to the Makarios Earth Station via microwave link, where it was connected to the uplink transmitter. The earth station here was a Class A Intelsat station utilizing a 30 meter or 90 foot dish and operated on 6 GHz. The signal was sent to the satellite and retransmitted to the Intelsat station in the U.S. at Andover

on 4 GHz, where it was then routed through the domestic terrestrial microwave system to New York. Once in the Big Apple, the signal was routed to the various networks for integration into the different news broadcasts. This entire process was repeated again and again—the only difference was point of origin as the word NEWS was shortened from North, East, South, and West. **PC**

## THE SHORTWAVE PROPAGATION HANDBOOK Second Edition

The all new revised 2nd edition of *The Shortwave Propagation Handbook* is here. Authors W3ASK and N4XX explore the whys and wherefores of how radio signals between 3 and 300 MHz travel over long distances under the influence of sunspots, the ionosphere, meteor trails, auroral ionization, sporadic-E, scatter phenomena, and other factors. Through fascinating text, amply supplemented by many charts, photos, and illustrations, you find out how to predict and use to your communications advantage the various types of skip openings—whether you're using a scanner to monitor the low or high VHF bands, an HF communications receiver or transceiver to pinpoint that hard-to-hear station, or are a 27 MHz operator or an Amateur operator looking for that rare country—the information in this book will tell you what you need to know so that you can take the fullest advantage of your communications facilities.

The all new 2nd edition of *The Shortwave Propagation Handbook* is only \$8.95, postpaid (sent by Book Rate Mail—allow time for delivery). Order now.

CQ Publishing

76 N. Broadway, Hicksville, NY 11801

Please rush me my copy of the 2nd Edition of *The Shortwave Propagation Handbook*:

\$8.95 for the book plus \$2 for shipping & handling.

Name \_\_\_\_\_

Address \_\_\_\_\_

City \_\_\_\_\_

State \_\_\_\_\_

Zip \_\_\_\_\_

Mastercard  VISA

My account number is: \_\_\_\_\_

### HEAR THE NEW BANDS ON YOUR SCANNER

Converts out-of-band signals to vhf or uhf scanner bands. Cables provided. Simply plug into scanner.



#### 6 MODELS AVAILABLE:

- 806-894 MHz New Land Mobile Band
- 894-960 MHz New Land Mobile Band
- 400-420 MHz Federal Government & FBI
- 240-270 MHz Navy/Air Force Satellites
- 135-144 MHz Weather Satellites
- 72-76 MHz Industrial & Radio Control

ONLY \$88 + \$3 S & H

### DIG OUT WEAK SIGNALS

Get clearer distant reception using ACT-1 POWER ANTENNA instead of scanner's built-in whip. This compact 21 - inch antenna has integral preamplifier, gives up to 15 dB gain (30 times as strong), plus all the advantages of a high antenna away from noise pickup. Often outperforms much larger indoor antennas!

Easy to install on any vertical surface indoor or out.

No mast required. Covers all bands: 30-900 MHz.

Complete with 50 ft. cable, ready to plug into scanner.

ACT-1 POWER ANTENNA

ONLY \$79 + \$3.40 S&H

• Order by phone or mail. Use VISA or MC, check, COD. SEND \$1 FOR COMPLETE CATALOG BY RETURN MAIL

**hamtronics, inc.**

65-B MOUL ROAD  
HILTON NY 14468-9535  
Phone: 716-392-9430

### REJECT SCANNER INTERFERENCE BOOST DESIRED SIGNALS

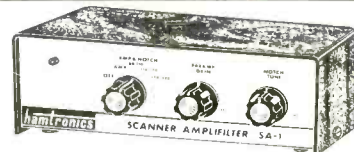

Do away with i-f feedthrough, images, cross-modulation, and other interference. Tunable 3-band VHF trap plus fixed i-f trap eliminate undesired signals. Low-noise preamp digs weak signals out of the noise. Adjustable-gain preamp can be used alone or with traps, giving you complete signal control freedom for 110-960 MHz bands.

SA-1 SCANNER AMPLIFIER

ONLY \$79 + \$3 S&H

## ANTENNAS AND SIGNAL IMPROVING ACCESSORIES

### Slanted-Wire Antennas For Tropical Bands

A single antenna for top performance on the 60, 75, 90 and 120 meter tropical bands is but a dream. The statement is especially true when you have a lot size limitation. Two separate antennas can be of help and, if you can use a single mast for both, a confined mounting space won't hamper you as much.

Any type mast can be used, and to save space, the antenna can be run along the mast from near the base to the top, Figure 1. Use insulated wire (#14 or #16 vinyl-covered) for your antenna wire and keep it separated about four inches away from any metal mast. If a plastic PVC piping mast is used, the antenna wire can be taped to the mast. Run the antenna wire along the mast to the top and then it can be passed through the eye of an eye-ring bolt. The antenna wire then continues out and downward to an insulator, forming the slanted-wire portion of the antenna. A rope and metal fence post keeps the end of the antenna wire about 5 to 7 feet above ground. Cut the antenna for a total of 1/4 wavelength on the desired tropical band. Dimensions are given in the chart. Remember that the length of the antenna wire is that length extending from the terminal at the base of the mast to the end of the slanting wire.

Use a coaxial transmission line with the inner conductor connected to the antenna terminal. The braid of the coaxial line can float and is attached to a second base terminal. A line from this terminal may be connected to a metal fence post that supports mast. An adequate ground must be used at the receiver.

The PVC piping mast lends itself well to supporting two separate tropical-band antennas. Antenna wires can be spaced and taped to the mast, Figure 2. Terminals are provided by three bolt/nut assemblies attached to the mast, Figure 3. There are two terminals for the antennas and a third terminal for connection of the coaxial braid.

The inner conductor of a single coaxial line can be connected to either antenna wire, Figure 4. At some sacrifice in pick up you can connect a jumper across the two antenna terminals and supply signal from both antennas to the inner conductor of the line. If at any time you plan some specific IDing or program listening on one of the bands, connect that antenna only to the inner conductor. An alternative plan is to use two separate coax lines and a two-position coaxial switch in the radio room.

There are four tropical bands, but in the USA the activities are concentrated on the

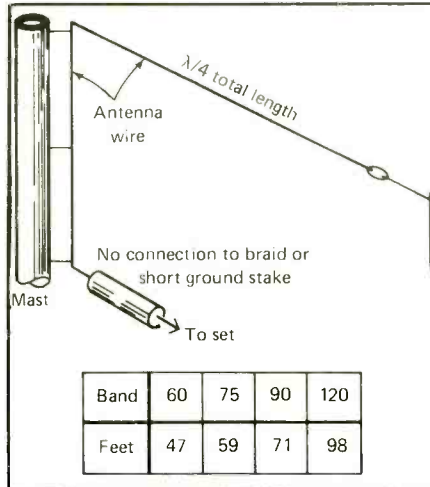

Figure 1: Tropical band slanted wire.

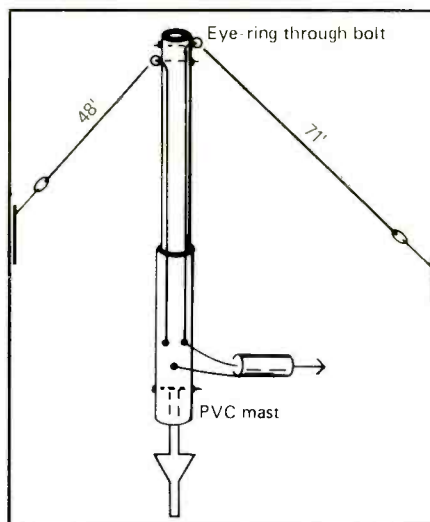

Figure 2: Antennas for 60M and 90M on same mast.

60 and 90 meter bands. Note the two antennas of Figure 2 are cut for these bands. They also provide acceptable coverage on the less active 75 and 120 meter bands.

A little bit of add-on trickery can do some peaking on these bands whenever you wish to do some special DXing on an individual band, Figure 5. A jumper add-on of 12 feet to the end of the 60 meter antenna can provide peak operation on 75 meters. This 12 foot length of antenna wire can be looped loosely around the support rope to the metal fence post. Bare the insulator end of the wire and attach a metal clip. When 75 meter peaking is desired, clip it on to the end of the 60 meter wire. To peak the 120 meter band, you need to add a considerable length of 27

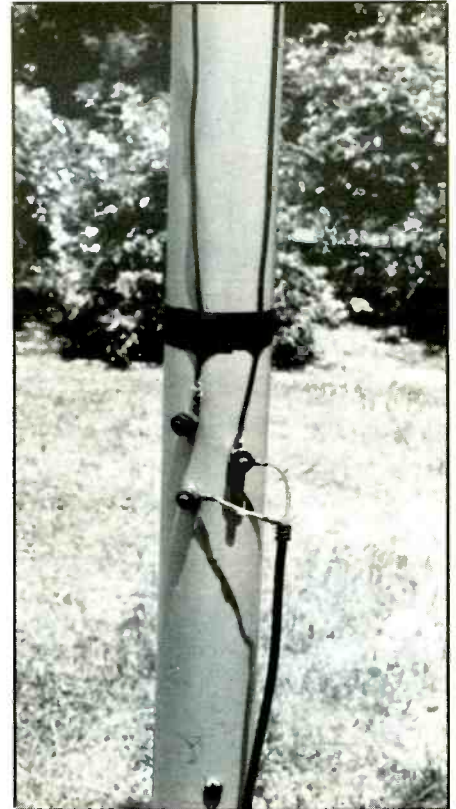
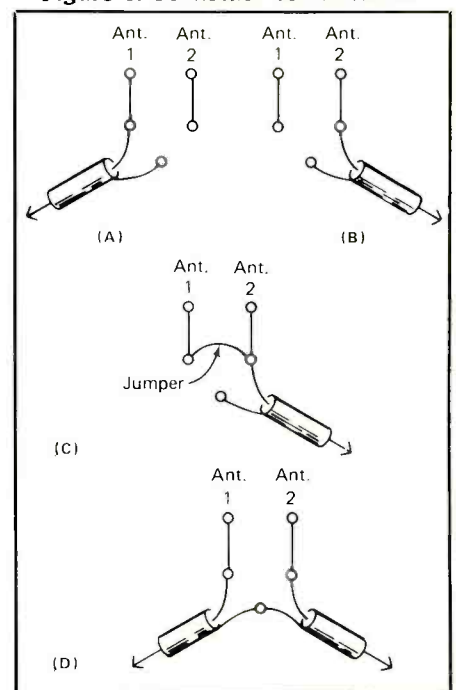

Figure 3: Antenna wires and coaxial line terminals at base of mast.

Figure 4: Connection combinations.





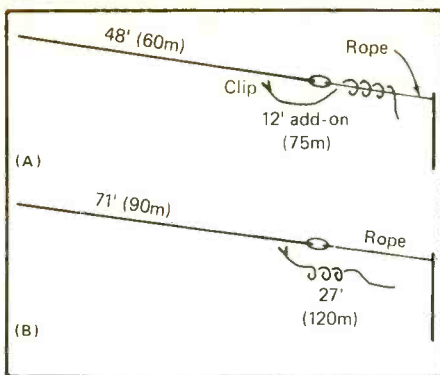

Figure 5: Add-ons that permit operation on any of the four bands.

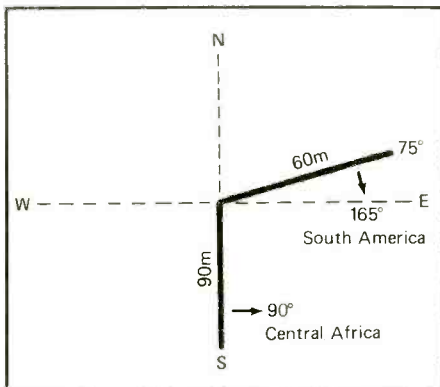

Figure 6: Typical orientation, eastern PA.

feet to the 90-meter antenna. This need not be a straight-away add-on if you are cramped for space. You can even use a spiraled wire on the ground.

### Orientation

The quarter-wave slanting wire displays maximum sensitivity broadside to the wire slope. There is less pick up directly away from the slope direction. The example of Figure 6 brings out these relations.

The 90 meter slanting wire antenna wire was sloped toward the south. By so doing it displayed maximum pick up at 90° toward central Africa. At the same time the pick up off its end toward the south is in the direction of Central and South America. Least pick up for this antenna is north. The 60 meter antenna was sloped approximately ENE. Thus its broadside pick up favors Central and South America. At the same time its end pick up is good in the direction of Africa. The two slanted-wire antennas do well in picking up signals from the tropical countries despite the limited amount of space they require.

Antennas also do well on the higher-frequency bands. The 90 meter version is, in effect, a sloping long wire for the higher frequencies. It is quite directive in the direction of the wire slope, which is toward the south. Consequently it favors many of the Central and South American stations that operate on the 19, 25, and 31 meter bands.

If your space requirements are more restricted, it is permissible to stretch out the two antennas in the same direction mounting the 60 meter antenna below the 90

meter one. Space the ground stakes to keep the ends of the two antennas approximately 5-7 feet above ground. In a test installation the two antennas were stretched out at an angle of 45° toward Europe. The 90 meter one had a broadside pattern on the 90 meter band and was directive toward the slope of the antenna for the 16, 19, 25, and 31 meter bands. This is an attractive angle that favors Europe on these higher frequencies and, at the same time, reduces pick up from the variety of stations transmitting from the continental United States. The 90 meter operation is a compromise, one that provides pick up from Africa and the Americas. The 60 meter antenna has broadside characteristics on the 41, 49, and 60 meter bands. Consequently it provides some favoring of the equatorial countries.

The mast arrangement of Figures 2 and 3 is quite versatile when you are checking antennas of various lengths and orientations. Perhaps you would like to file this issue and the previous two, which presented several ideas on mast construction. Future coverage may refer to these various forms, which will save space in future columns for new material because they will not be repeated. Next month's material will expand information about slanting-wire antennas. Quite often gain is not the consideration—rather, it is the directivity and ability to reduce somewhat the signals that arrive from some bothersome direction that is helpful.

PC

## antennas

H. C. Van Valzah Co.  
Downers Grove, IL 312/852-0472

### Butternut Trombone® SC-3000 Scanner Antenna for the "Pros"

UHF 7dB VHF 3dB \$57<sup>95</sup>  
Low Band Unity  
gain pull in the weak  
signals that aren't there on  
conventional antennas.

Antennas are our  
only business!

SWL antennas from  
B&W, Butternut & Mosley  
CB from Antenna  
Specialists Hustler,  
Wilson, Avanti

Add \$3.00 for shipping in U.S.  
Check our low prices on all nationally advertised antennas  
and accessories. Send 50¢ for antenna catalog—48 pages.

TO ORDER CALL

1-800-HAM 0073  
H. C. Van Valzah Co.

1140 Hickory Trail  
Downers Grove, IL 60515  
Satisfaction Guaranteed

## ! NOW AVAILABLE! schottky diode

### RECEIVER MOD

INEXPENSIVE MOD MAKES A BIG DIFFERENCE!  
LOWER NOISE - MORE LINEAR DETECTION  
ONLY FROM YOUR FRIENDS AT RADIO WEST

\$35 (INC AM/SSB DIODES IN COMMUNICATION  
RECEIVERS)

\$25 (AM ONLY IN PORTABLES) Catalog-\$1.00

**RADIO WEST**  
(619) 741-2891  
3417 Purer Rd. Dept. PC  
Escondido, CA 92025

CIRCLE 65 ON READER SERVICE CARD

## SATELLITE TV

BUY AT DEALER COST!

- 6' Ring Mount Systems \$ 799-\$ 999
- 6' Motorized Systems \$1199-\$1399
- 10' Motorized Systems \$1599-\$1799

SEND \$5.00 FOR HEFTY INFO-PAK INCLUDES ILLUSTRATED FULL COLOR BOOK "SATELLITE TV & YOU" COMPLETE CATALOG OF ALL SYSTEMS. SAMPLE TEN STEP ILLUSTRATED DO-IT-YOURSELF INSTALLATION GUIDE & LATEST PROGRAM GUIDE LISTING OF WHAT'S UP THERE — OVER 100 SATELLITE TV CHANNELS!



SATELLITE EXPRESS, INC.  
162 Hubbard Way, Suite F,  
(Dept. 22) Reno, NV 89502

or call  
(415) STV-DISH

CIRCLE 138 ON READER SERVICE CARD

SPECIAL!!

## BIG "D" Sale Prices



**SONY**  
**31 Band ICF2002**  
Digital Key Touch Shortwave  
AM, FM, MW, SSB/CW  
BROADCASTS

Regular  
\$249.95

SALE PRICE  
**\$209.50**  
plus \$5.00  
shipping U.S.A.

- Ten station/memory presets
- Automatic scan
- Built-in quartz clock

1-800-441-0145 (In Texas) • 1-800-527-2156 ask for Ham Dept.

ALSO ASK ABOUT  
super saving prices on  
Kenwood, Icom,  
Encomm, Yaesu and  
all ham items.

**electronic center, inc.**

ROSS AT CENTRAL EXPRESSWAY, DALLAS, TX 75201



CIRCLE 84 ON READER SERVICE CARD

November 1985 / POPULAR COMMUNICATIONS / 51

# LISTENING POST

BY GERRY L. DEXTER

## WHAT'S HAPPENING: INTERNATIONAL SHORTWAVE BROADCASTING BANDS

It shouldn't be a whole lot longer before Kenya becomes far easier to hear on shortwave, if it hasn't happened by the time you read this. Transmitters of 250 kilowatts are due to go on the air for the Voice of Kenya at any time. In a reversal of the way things usually work, the Kenyan government hadn't yet decided on the purpose of the new transmitters—whether to use them for domestic/regional purposes or to put them into operation as an international service. The most recent schedule registered with the International Telecommunications Union would seem to indicate they may start out with the former. Check for Kenya from 0300-0600 on 7.135 and 7.220, 0600-1600 on 9.635 and 9.725, and 1600-1900 on 7.135 and 7.220.

Another African nation that has increased power to the "it's a snap" level is Burkina Faso (formerly Upper Volta). Radiodiffusion-Television Burkina at Ouagadougou remains on its usual frequency of 4.815, but now with a much stronger signal, rivaling that of Africa Number One on 4.810 from Gabon. Check late in the afternoons to 0000 sign off or from sign on at 0600. Broadcasts are all French and local languages.

On the U.S. shortwave scene, NDXE has been delayed at least until the fall (and we'll project that the start-up date will be much later than that). Meantime, NDXE is offering an Alabama highway map to all who request it. Send two IRCs to NDXE, Box 569, Opelika, Alabama 36801.

WMLK in Bethel, Pennsylvania and KCBI in Dallas, Texas were both running test broadcasts in mid-summer and now there's word that the *Christian Science Monitor* is thinking about putting a shortwaver on the air. This one would use at least two different transmitter sites, probably in the northeast and southeast parts of the country.

Radio Earth has begun their European service over the semi-private station Radio Milano International in Italy. Initial broadcasts are running two hours each Sunday from 0800-1000 on 7.295, with plans to expand that from 0800-1500 in early fall. Some well-equipped eastern area listeners might be able to hear this one. We expect to bring you details on Radio Earth's western hemisphere activity plans next month.

The Voice of Germany has run into trouble at its new Sri Lanka relay site. The station there has been under attack by Tamil terrorists, goods have been stolen and an approach bridge blown up. One news report says Deutsche Welle has abandoned the project entirely, although it seems more likely this may just be a temporary halt in operations until things cool down.

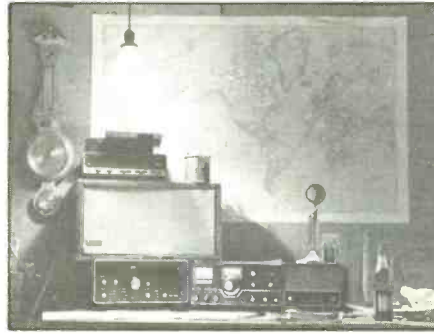

This shack belongs to Paul Sadler III in Hampden, Maine. The bottle is an invaluable aid to DX'ing.



This attractive QSL from Radio Kiev was received by Eric Gardner.

The new edition of the *Tropical Bands Survey* from Danish Shortwave Clubs International is now out and a "must have" for anyone who listens to the lower shortwave frequencies. Its 32 pages covers all of the broadcast stations operating between 2.000 and 5.900 MHz, based on monitoring information supplied by top DX'ers around the world. You can order one, Air Mail, for 8 IRCs direct from DSWCI, Tavleager 31, DK-2670 Greve Strand, Denmark. Or you can get a copy for \$4.50 from Gilfer Associates, P.O. Box 239, Park Ridge, NJ 07656.

### In The Mailbag

Let's monitor the mail. Jerry Brookman checks in from Kenai, Alaska to note that he uses a Kenwood R-600 with a 75 foot end-

fed wire antenna. He notes that he gets frequent wintertime reception of Russian longwave stations and that some of the garden variety shortwave outlets aren't so common in Alaska. Jerry did manage a recent logging of the Falkland Islands way up there.

Greenwich Gremlins got into our explanation of GMT vs EST in the July issue. David E. Licht points out that 7 p.m. EST equals 0000 GMT and that there should have been no reference to Daylight Time in that context. Licht notes that 0000 equals 8 p.m. EDT but he says that 0001 equals 9 p.m. EDT. He means 0100 of course, just to show you how easily the gremlins can gum the works.

Larry R. Fravel in Clarksburg, West Virginia has been camping over the summer and listening with a portable. He's up to 146 countries heard and 112 verified.

Sara Vickers of Pittsburgh has rediscovered shortwave listening and is really going at it, reporting a number of QSLs in already. She received a calendar and bumper sticker from the Voice of America. Guess that was a slip up by the VOA as Americans living within the U.S. aren't normally favored with anything other than QSLs. We're tried several times to get on the mailing list for the VOA's *Voice* magazine without success. Generally the VOA stays pretty close to the laws that forbid the station to supply any kind of service or promotional material to domestic listeners.

Edouard S. Provencher in Biddenford, Maine says he's getting excellent reception of Radio Marti at 1400 on 11.815. Another reader is under the impression that Radio Marti is beamed from Trans World Radio on Bonaire! They aren't, of course, although both stations use 11.815.

Art J. Harris, N2AH, in Kings Park, New York is returning to listening after several years away. Art started in 1963, got into ham radio in 1969, holds a general class call and is now tuning the SWBC bands, too. Art asks about deadlines. The column is prepared in the middle of the month, so if reporters put material in the mail during the latter part of the preceding month, we're sure to get it.

POP'COMM has generated activity by Jack Linonis in West Middlesex, Pennsylvania, who was also inactive for several years. Jack uses a DX-160A and would like to hear from others with the same receiver. You can write Jack at 1890 South Hermitage Road, West Middlesex, PA 16159. Jack also wonders if the Newark News Radio Club is still active. 'Fraid it has been gone for a few years, Jack. But some ex-NNRC members have formed the Association of DX Reporters, which issues a monthly bulle-





Patrick Griffith in Denver is building himself a QSL wall.

tin covering SWBC, utilities, hams, broadcast band, FM and TV DX. Membership is \$15 per year from ADXR, 7008 Plymouth Road, Baltimore, MD 21208. Sample issue is \$1 from that address.

Valerio Borghese of Australia is a newcomer to the hobby who has inched his way up to a Yaesu FRG-7 and has a particular interest in hearing African stations. We are here and you are there, Valerio, so it's hard to say what the most common Africans are in your part of the world. You might consider joining an Australian club and finding help there. Try DX Australia, P.O. Box 285, Mt. Waverly, Victoria 3149. Valerio would like to correspond with other Listening Post readers and can be reached at 4 June Pde., Woonona Heights, 2517, New South Wales, Australia. He's in our photo gallery this month.

So is Paul Sadler III of Hampden, Maine. Paul says that reception in Maine is superior to that in his native Arizona. He's looking for a local club he can join.

Alex Batman says he has really gotten into listening in a far bigger way than he'd expected. He's logged 118 countries since he started last January! Alex now has a column called "Easy Listening" in *Frendx*, the bulletin of the North American Shortwave Association. The column focuses on the programming one can hear on shortwave. NASWA, incidentally, is probably the biggest U.S. shortwave club and deals with shortwave broadcasting exclusively. Dues are \$16 per year (First Class to North America) from 45 Wildflower Rd., Levittown, PA 19057.

Nice to spend a day with Sheryl Paszkiewicz and John Meyer of Manitowoc, Wisconsin recently. One day Sheryl and I will get John reporting to these pages.

Remember to keep those cards and letters coming, folks. Comments, questions, loggings, shack photos, copies of your more in-

teresting QSLs, program schedules, clippings and whatnot are always welcome. When sending loggings, please list items by country, include your last name and state abbreviation after each, leave plenty of room between items, and use one side of the paper only. It makes our job a lot easier! We look forward to hearing from you next month!

### Listening Report

Here's what's on. All times are GMT.

**Alaska** KNLS in Russian at 1014 on 9.685 and in English from 0750 on 11.850. (Batman, LA)

**Albania** Radio Tirana heard at 0337 on 6.200 with report on upcoming film festival. (Vickers, PA)

**Antigua** BBC Relay in English and Spanish with English/Spanish lesson ending at 0245, into Spanish on 6.155 (Gardner, MD)

**Argentina** RAE on 15.345 at 1248 in English ending newscast, into music. (Shute, FL) English at 0100 on 9.690 and 11.710. (Harris, NY)

**Australia** Radio Australia's Papua New Guinea Service personally preferred over regular RA programs. Noted with "Waltzing Matilda" theme from 0750 on 6.060, 6.080, and 9.580 going parallel with 6.045, 11.720, and 11.910 at 0800. 6.080 is separate. (Alpert, NY) 9.580 at 1255 in English. (Harris, NY) 1300, English, very strong. (Linonis, PA) 1246-1310. (Fravel, WV) 5.995 at 0957-1011 music program in Melanesian, seemed requests. (Fravel, WV)

ABC Brisbane, 4.920 weak at 0705. (Batman, LA)

**Austria** Austrian Radio with interval signal just before 0500 on 9.635. (Lyster, BC) 15.320 in English at 1216 with jazz show. (Shute, FL) 0130-0154 on 6.000 in English. (Harris, NY)

**Belgium** RTBF at 1500 on 21.460. (Patton, FL) BRT with Brussels Calling at 0030 in English to North America on 5.910 and to South America on 9.925. (Harris, NY)

**Brazil** Radiobras on 11.745 at 0230. (Lyster, BC) English 0200-0300. (Batman, LA) 0230 in English. (Gardner, MD) 0220 with English to North and Central America. (Pastrick, PA)

Radio Nacional Amazonia at 0211 on 15.290, frequencies, address. (Vickers, PA)

Radio Nacional Manaus on 4.845 at 0945 in Portuguese, Latin music. IDs and announcements by man. (Paszkiewicz, WI)

Radio Nacional Tabatinga, 4.815 at 0300, ID 0330. (Batman, LA)

Radio Globo, 11.805 at 0112, music. Portuguese announcements. (Lingenfield, VA)

**Bulgaria** Radio Sofia, 11.750 in English at 0300-0357, news. Midweek Mailbag, music. (Stoddard, TX) 11.735 at 2030 in English with frequencies. (Vickers, PA)

**Burkina Faso** Radiodiffusion Television Burkina, 4.815 at 0559 in French with national anthem, announcements, local music, choir, soul music, ID, and news following at 0630. Good and QRM'ing Africa No. 1 on 4.810. (Paszkiewicz, WI)

**Cameroon** RNC at Yaounde heard at 2100 on 9.745 with news, sports, music, IDs. (Miller, GA)

Radio Douala on 4.745 noted in French at 0511. (Lingenfield, VA) Do you mean Douala on 4.795 or Bertoua on 4.750? (Editor)

Radio Bafoussam on 4.000 at 0500 very good in French with African drums. (Lingenfield, VA)

**Canada** Radio Canada International, English to Latin America at 0100 on 11.940, 15.190, and 17.820. (Willevier, IN) 17.820 at 2130 in English to Africa. (Linonis, PA)

**Chad** RNT at 0520 on 4.904 in French. Weak. (Batman, LA)

**China** Radio Beijing on 11.860 at 1200. (Patton, FL) 11.860 and 11.650 in English at 1206 with news. ID, news about China. 11.860 best. (Shute, FL)

**Colombia** Radio Nacional on 9.635 at 0500 with sign off. Difficult. (Lingenfield, VA) Also 17.713 LSB at 2240. (Lingenfield, VA)

Radio Super, Medellin, 4.876 at 0620, call-in show in Spanish. (Lingenfield, VA)

**Costa Rica** Radio Colombia, 4.850 at 1028 in Spanish with music, frequent IDs, and time checks. (Fravel, WV)

**Cuba** Radio Havana now using 6.100 for English to

## Delaware Amateur Supply

71 Meadow Road, New Castle, Del. 19720  
Factory Authorized Dealer! 302-328-7728  
9-5 Daily, 9-8 Friday, 9-3 Saturday

KENWOOD, ICOM,  
YAESU, MICROLOG,  
KANTRONICS, AEA

Order & Pricing

800-441-7008

NO Sales Tax in Delaware! one mile off I-95

Please send all reader inquiries directly.

### SATELLITE TV - INSTALL YOUR OWN!

Our \$6 instruction manual and technical hotline will assist you. Our low prices on quality systems will save you hundreds!

Call (800) 382-STAR or  
CA. (707) 826-1590

SSD

530 Warren Creek Road  
Arcata, CA 95521

## SWLS - HAMS

CALL TODAY FOR ALL  
YOUR SWL & HAM NEEDS

\*RECEIVERS \*ANTENNAS

\*TRANSCIEVERS \*RTTY

\*PUBLICATIONS \*SWL

YAESU \*KENWOOD \*ICOM

HARDIN ELECTRONICS

5635 EAST ROSEDALE  
FORT WORTH, TEXAS 76112

1-800-433-3203

IN TEXAS 817-429-9761

Please send all reader inquiries directly.



Golden State

Communications

P.O. Box 1052 Dept. B  
Los Alamitos, Ca. 90720

### PANASONIC SALE!!!

RF-B300 FM/MW/SW 1.6-30 MHz..... \$199.95  
RF-3100 FM/MW/SW 1.6-30 MHz..... 259.95  
RF-B600 FM/LW/MW/SW 1.6-30 MHz..... 399.95  
"EAVESDROPPER" SWL Antenna..... 59.95

1985 World Radio TV Handbook \$16.95

CALL NOW AND SAVE! (213) 430-8395

7AM - 5PM Pacific Time, Monday - Saturday

FREE SHORTWAVE CATALOG

We also carry a complete line of quality marine electronics.

Prices do not include shipping and are subject to change without notice.

North America. Heard 0500, parallel 6.090 and also announcing 9.745, 11.725. Off at 0600. Also noted starting English news at 0700 on 9.525 but off in mid-sentence at 0709 then open carrier from 0712. (Alpert, NY) 9.740 at 0404, parallel 6.090 with Latin American news in English. (Shute, FL) 6.100 at 0115 in English with mailbag show. (Pastrick, PA)

**Czechoslovakia** Radio Prague on 7.345 with English mailbag and "Music for Tape Recorders." (Gardner, MD) 0332 on 11.990 with North American service. (Stoddard, TX)

**East Germany** Radio Berlin International, 11.975 at 0030 in English to North America. (Pastrick, PA)

**Ecuador** HD210A time station at Guayaquil on 7.600 at 0500. (Lyster, BC)

HCJB on 11.910 at 0049 with religious show in English. (Pastrick, PA) 9.745 at 0040 with news in English. (Harris, NY)

**Egypt** Radio Cairo, English to North America at 0240 on 9.4475. Commentary and instrumental music. (Pastrick, PA) Home service in Arabic noted at 2335 on 12.050. (Brumm, IL) 9.475 at 0220 with news and commentary. (Linonis, PA) 0243 with program about camels. (Shute, FL) 0200 in English, also poorer on 9.675. (Harris, NY)

**England** BBC now using the "Optimod" processing system in their audio systems according to the BBC Waveguide program. Same program notes there'll be no ball-by-ball cricket coverage this season. BBC can't afford the transmission costs. Live reports on the matches were scheduled daily at 1115 and 1445. (Alpert, NY)

**Finland** Radio Finland International on 15.400 at 1400 in English with news and program about Finnish athletes. (Linonis, PA)

**French Guiana** RFI relay on 15.365 good at 1555 in Portuguese and English. (Shute, FL) 9.800 at 0000 with sign on in French. (Lyster, BC)

**Gabon** Africa No. One on 15.475 at 2000 in French with pop/rock and African music, some English announcements, news at 2100. Also on 15.200 at 1518 in French. (Paszkievicz, WI)

**Greece** Voice of Greece, English at 1543 on 15.565 with news. (Shute, FL) 9.420 at 0200 in Greek. (Linonis, PA) 9.905 at 0130 in English to North America. (Pastrick, PA)

**Guatemala** Radio Tesulutlan 4.835 at 0201 with music and talk. (Fravel, WV)

**Guyana** GBC at 0440 on 5.950 with English talk, ads, music. Off 0500. (Miller, GA)

**Honduras** HRVC La Voz Evangelica, 4.820 in Spanish at 0135-0200. (Fravel, WV)

**Hungary** Radio Budapest on 9.835 at 0223 in English. (Harris, NY) 6.025, parallel 6.110 at 0230 in Hungarian with news. (Vesei, MI)

**India** All India Radio in English from 2155-2230 on 11.620 with widely varying signal quality from day to day. (Batman, LA)

**Indonesia** Voice of Indonesia 0915-1000 in Maylay with traditional and popular Indonesian music. English ID at 1000 sign off. (Batman, LA) 1501 on 11.790 with news, poor audio quality made it difficult to understand. (Shute, FL)

**Iran** Voice of the Islamic Republic of Iran in Farsi on 15.084 with music and commentary from 1928 tune. "Bubble" jammer on frequency but seems minor. (Batman, LA)

**Iraq** Radio Baghdad on 9.610 at 2100, too weak to ID language but at 2125 was an ID and schedule of transmissions in English. (Batman, LA) 2130 in English with war news, Arabic music. Takes a long time to QSL but the packet is well worth it. (Linonis, PA)

**Ireland** Radio Dublin International heard on 6.910 at 0415 with usual pop music, poor. (Shute, FL) 0400 with ID, Top 40, time checks, and advice to "turn your radio on Radio Dublin." (Miller, GA)

**Israel** Voice of Israel 11.655 at 0020 with English to North America and "Arts in Israel." (Pastrick, PA) 9.435 at 2200 in Hebrew with news and possible Hebrew language lesson. (Linonis, PA)

**Italy** RAI 9.575 with monotone YL and news in English at 0100, also 11.800, poor modulation. (Harris, NY) News at 0100. (Pastrick, PA) 9.575 and 11.800 with interval signal. (Vesei, MI) 11.800 at 0100 news and music. (Linonis, PA) 9.575 and 11.800 at 0100. (Griffith, CO)

**Japan** Radio Japan 9.505 at 1523. (Lyster, BC) 17.755 in English at 0100 with news, current affairs. (Miller, GA) 9.505 at 1715, 17.755 at 0255, 17.825 at 0200, all English. (Griffith, CO)



*Russell Rothschild specializes in listening to the 7 MHz SW broadcasters from his listening post in Galway, Ireland.*



*Valerio Borghese seeks Africans and correspondents at his New South Wales, Australia listening post.*

**Kuwait** Radio Kuwait on 11.675 at 1910 in English with rock. (Harris, NY)

**Lithuanian SSR** Radio Vilnius in English 2200-2230 on 9.685. (Batman, LA) 15.100 at 2315 in English. (Linonis, PA) All via R. Moscow transmitters. (Editor)

**Lesotho** Radio Lesotho, 4.800 in English at 0500 but very faint. (Gardner, MD) 0500 under heavy utility QRM and static. (Lingenfield, VA)

**Libya** Radio Jamahiriya, 11.815 at 2205 in English. (Griffith, CO)

**Luxembourg** Radio Luxembourg 15.350 in presumed French with Top 40, weak. (Linonis, PA) 6.090 in English at 0019 with American-style DJ and listener call ins from United Kingdom. (Harris, NY) Weak at 0015. (Vesei, MI) Heard til 0100 when covered by Havana. (Batman, LA) 2315 with pops, commercials, ad for contest. (Shute, FL)

**Malta** Radio Mediterranean, in English but QRM'd on 6.110 at 2300. (Harris, NY)

**Mauritania** Radiodiffusion Television de Mauritanie, at 0625 in Arabic on 4.845 but quick fade. (Batman, LA) 0558 with Mauritanian guitar music. (Shute, FL)

**Mexico** La Voz de la America Latina, XEWW from 2043-2100 on 15.160, fair but covered by VOA at 2100. (Batman, LA)

**Mongolia** Radio Ulan Bator in English at 1200 to 1235 on 12.015. (Batman, LA)

**Monte Carlo** Trans World Radio in English from 0735 on 9.495, very weak, with heavy noise. (Batman, LA)

**Morocco** Radiodiffusion Television Marocaine, Arabic music and commentary on 15.335 at 1340. 17.595 at 1400, both poor. (Batman, LA)

**Mozambique** Radio Maputo, 11.818 at 0550, weak, in Portuguese. (Lingenfield, VA)

**New Caledonia** RFO Noumea in French with pop music 0738 and news in French at 0800. (Batman, LA) 7.170? (Editor)

**Netherlands** Radio Netherlands, Flevo transmitter, 9.895 with English 0130-0225, parallel 6.020. (Batman, LA) 9.895 best of the two at 0100. (Harris, NY) 0130 with world news, "Newline," "Images," "Dutch by Radio." (Willever, IN)

**Netherlands Antilles** Radio Netherlands relay,

6.165 with English to North America 0239. (Pastrick, PA) 0508 in Dutch to Central America. (Lyster, BC)

Trans World Radio, Bonaire, 1115-1200 in English on 11.815. (Batman, LA)

**New Zealand** Radio New Zealand International on 15.150 at 0619 in English. (Griffith, CO) 11.780 at 0600, QRM from Deutsche Welle. (Lingenfield, VA) 0300 in English on 15.150 with news. (Linonis, PA) Classical music at 0420. (Batman, LA)

**Nicaragua** Voice of Nicaragua, 6.015 with English at 0143. (Harris, NY)

**Northern Marianas** KYOI Saipan in 11.900 at 1201 with usual pops, ID in Japanese. (Shute, FL) 1204 with English, Japanese announcements. (Fravel, WV)

**North Korea** Radio Pyongyang on 11.655 at 0726 in English. (Brookman, AK)

**Norway** Radio Norway International on 15.305 at 1300 with Norway Today program. (Miller, GA) Interval signal and ID in English at 1255. (Shute, FL)

**Pakistan** Radio Pakistan at 1600 on 17.660 with General Overseas Service in English, frequency announcements, news, abrupt off at 1615. (Shute, FL) English from 0230-0245, parallel 15.175. (Batman, LA)

**Paraguay** Radio Nacional, classical music and Spanish announcements at 0100 on 9.735. (Batman, LA)

**Philippines** FEBC on 15.445 at 2310 in English. (Griffith, CO)

VOA Relay on 9.555 and 6.185 with sign on in Chinese at 1000. (Batman, LA)

**Poland** Radio Polonia at 0230 on 7.145 with "Panorama," ID classical music. (Miller, GA)

**Portugal** Radiodifusao Portugal on 6.095 at 0300 in English with news. (Gardner, MD) 0056 with tape of Radio Earth. (Harris, NY)

**Rwanda** Deutsche Welle Relay at Kigali on 11.705 in German at 2300, relay ID in French. Stronger than Radio Sweden on same frequency at the same time. (Batman, LA)

**Seychelles** FEBA in Swahili from 0325-0400 sign off on 9.610. Religious programs. (Batman, LA)

**Sierra Leone** Sierra Leone Broadcasting Service, 5.980 with national anthem at 2200 then news. Any hope for a QSL? (Vesei, MI) Fairly good. (Editor)

**Somalia** Radio Mogadishu in either Arabic or Swahili on 7.200 at 0258-0330. (Batman, LA) Why not in Somali? (Editor)

**South Africa** Radio RSA, 6.010 at 0234 in English to North America. (Pastrick, PA) 0200 with ID and news. Bad QRM. (Gardner, MD) 5.980 in English at 0200 with IS, news and commentary. (Linonis, PA) 7.270 at 0428-0506 in English and French. (Lyster, BC)

**South Korea** Radio Korea at 1420 on 15.575 in English with "Echos of Traditional Music." (Gardner, MD) 1445 in English with "Shortwave Feedback" including listener's letters. (Shute, FL) 1400 with news, sports, commentary, ID, Korean lesson. (Miller, GA)

**Spain** Radio Exterior de Espana, 11.880 at 0036 in English to North America. (Pastrick, PA) 2240 in English on 9.780. (Paszkievicz, WI) 9.630 in English at 0131. (Lyster, BC)

**Surinam** Radio Surinam International (via Brazil) on 17.755 at 1801 in Dutch but with 3 minute English newscast. (Vesei, MI)

**Syria** Syrian Arab Republic Broadcasting Service on 12.085 in Portuguese at 2345-2355. (Brumm, IL) 2000 in English with news, ID, press review, music program hosted by a woman with talk, news summary, anthem, and off 2100. (Miller, GA)

**Sweden** Radio Sweden International 11.705 at 0335 in English. (Griffith, CO) 0030 with IS and ID in several languages, before broadcast in Portuguese. (Batman, LA) 0230 in English with Weekday Program, news, editorial comment. (Miller, GA) 9.695 in English at 0230. (Harris, NY) 15.345 in English at 1420. (Gardner, MD)

**Switzerland** Swiss Radio International on 9.725 at 0209 in English with "Dateline." Better on parallel 12.035. (Pastrick, PA) 0410-0420 on 9.725. (Lyster, BC) 9.725 and 9.885 with Swiss music 0145, news in English 0200. (Harris, NY) 12.035 at 0400 in English. (Stoddard, TX) 0200 with "Dateline Friday." (Gardner, MD)

**Tahiti** Radio Tahiti on 15.170 at 0300 with flute and drum IS, then music and announcements in Tahitian, into French at 0600. (Linonis, PA) 2200 in French on 15.170. (Batman, LA)

**Taiwan** Voice of Free China, via Florida, on 5.985 at 0241 with English to North America. (Pastrick, PA) 0215 with "Spotlight" program. (Linonis, PA) 9.680 at 0120 with program on Chinese history. (Lyster, BC)



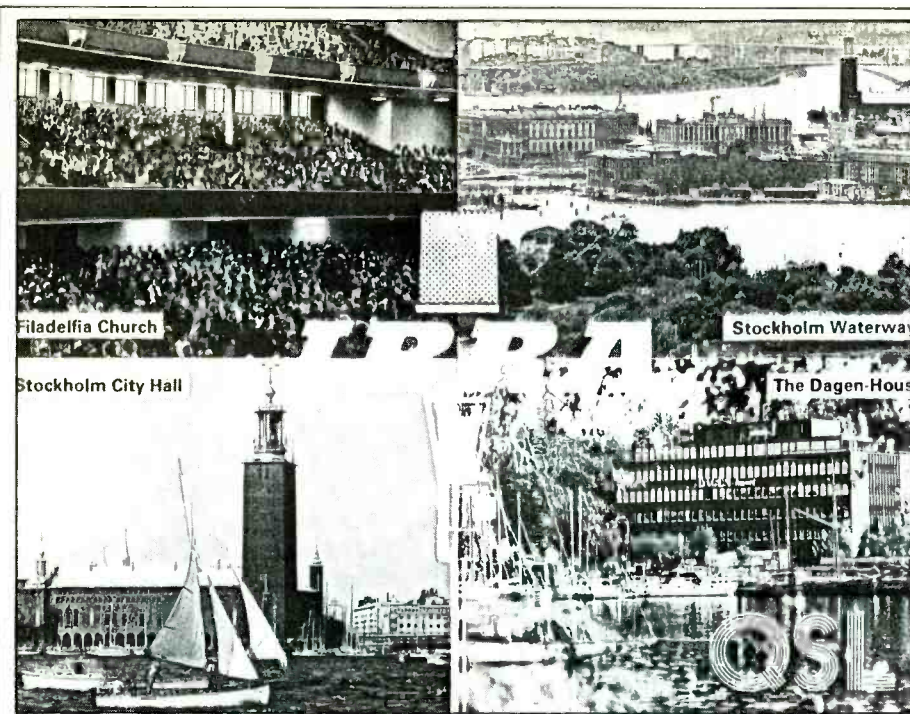

Elmer J. Cronkright in Wyoming, Michigan got this large card from IBRA Radio via the Malta transmitter.

**Togo** Radiodiffusion Togolaise, 5.047 in French at 0620, Lome ID at 0630,0700. (Batman, LA)

**Turkey** Voice of Turkey on 9.560 at 2200, examples of Turkish music. (Vesei, MI)

**United Arab Emirates** UAE Radio, Dubai, English at 0400 on 7.130. (Gardner, MD) 9.695 at 0300 in English to North America. Address? (Linonis, PA) P.O. Box 1695, Dubai, UAE. (Editor)

**Ukrainian SSR** Radio Kiev, English with "Ukraine Today" at 0200 on 11.720. (Gardner, MD) Via Radio Moscow transmitters. (Editor)

**USA** Radio Marti, 9.660 at 0200 in Spanish with U.S. pops. Also 1300 sign on on 9.570 in Spanish. (Harris, NY) 9.660 at 0123 in Spanish with frequency schedule. (Shute, FL) 0220 in Spanish. (Griffith, CO) 11.930 from 2030 to 2300. (Kaiser, IL)

La Voz de las OAS (Organization of American States) 15.160 at 0028 in Spanish. (Pastrick, PA)

KCBI, Dallas, with equipment tests on 11.790 from 1830-1900, music with ID and location. (Miller, GA)

WMLK Bethel, PA with tests on 15.510 at 0430 reque-  
sting reception reports. (Vesei, MI) 15.110 at 1714 with Elder Jacob O. Meyer reading passages from Sacred Scriptures, Bethel edition. Announced as test, said broadcasting to Zones 27, 28, and 30. (Paszkievicz, WI)

WRNO New Orleans on 7.355 at 0130 in English. (Pastrick, PA)

AFRTS, 6.030 at 0225 in English to North Atlantic, baseball. VOA Bethany facility. (Pastrick, PA) Has added "Newsmark," CBS weekly documentary program to schedule, airs at 0230 and 0730 Sundays, replacing RKO's "Equal Time" program, apparently cancelled by RKO (Now United Stations Network). Also new is "Armed Forces Radio Newsfeed" Monday-Friday at 0435 and 0935. (Alpert, NY)

**Vanuatu** Radio Vanuatu in English with pop music at 0918 on 7.260, parallel 3.945. (Batman, LA)

**Venezuela** Radio Mundial Bolivar, Ciudad Bolivar, on 4.770 at 0259 in Spanish. Frequent IDs, ad for mineral water. Off at 0300. (Shute, FL)

Radio Rumbos, Caracas, 4.970 at 0400 in Spanish. Very strong, lots of Latin music, excellent QSL policy for Spanish reports. (Linonis, PA)

Radio Maturin, Maturin, 0332-0400 sign off on 5.040. Latin pops, Spanish. (Batman, LA)

**Vietnam** Voice of Vietnam 15.010 at 1347 in English with mailbag, local music, off 1357. (Paszkievicz, WI)

**West Germany** Radio Free Europe in Hungarian on 11.895 at 1910. (Vesei, MI)

Deutsche Welle on 6.145 at 0120 with wine series. (Harris, NY) Via Antigua on 6.040 at 0109 in English.



Andrew Farmer in North Vancouver, British Columbia does his DXing and works CB from this well-equipped shack.

(Pastrick, PA) Stage play and sign off 0143-0150. (Lyster, BC) 11.795 at 2349 in German. (Lyster, BC)

**Yugoslavia** Radio Yugoslavia in English at 2130-2145 on 9.620. Spanish from 2145. (Batman, LA)

Many thanks to: Sheryl Paszkiewicz, Manitowoc, WI; John Miller, Thomasville, GA; Patrick M. Griffith, Denver, CO; Eric Gardner, Cambridge, MD; Alex Batman, Baton Rouge, LA; Robert Pastrick, Conway, PA; George Kaiser, Chicago, IL; Jerry Brumm, Chicago, IL; S. Lyster, Keremeos, BC, Canada; Michelle Shute, Pensacola, FL; Linda Stoddard, Sulphur Springs, TX; Jack Linonis, West Middlesex, PA; Gil Patton, Merit Is., FL; Art Harris, N2AH, Kings Park, NY; Sara Vickers, Pittsburgh, PA; Darrell Lingenfield III, Woodbridge, VA; Larry R. Fravel, Clarksburg, WV; Lloyd J. Willever, New Palestine, IN; Gerald R. Brookman, Kenai, AK; Chuck Vesei, Niles, MI; and David R. Alpert, New York, NY.

'Til next month, good listening!



## Be No. 1, Run Jo Gunn



JG-RV

Star Series



1st & Only Stracked RV  
On Today's Market

JG 4 + 4 Star

V Series

Super Audio  
Flat Series

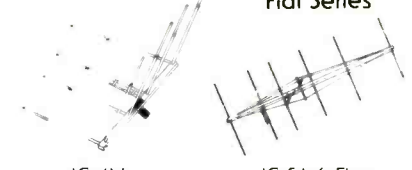

JG 4V

JG SA 6 Flat

VARIOUS SIZES  
AND MODELS  
AVAILABLE.

"The Antenna Built For The CB'er  
Who Demands The **BEST** In  
**PERFORMANCE** And **QUALITY**"

Call or Write **Jo Gunn Enterprises**  
For More Route 1 - Box 383  
Information: Ethelville, Alabama 35461  
(205) 658-2595

CIRCLE 111 ON READER SERVICE CARD

TUNE IN THE WORLD WITH

### HAM RADIO

Your passport to ham radio adventure is TUNE-IN THE WORLD WITH HAM RADIO. Book tells what you need to know in order to pass your Novice exam. Cassette teaches the code quickly and easily.

Enclosed is my check or money order for \$8.50 or charge my  
 VISA  Mastercard ( ) Am. Express

Signature \_\_\_\_\_  
 Acct. No. \_\_\_\_\_  
 Good from \_\_\_\_\_ Expires \_\_\_\_\_  
 Name \_\_\_\_\_  
 Address \_\_\_\_\_

City \_\_\_\_\_ State \_\_\_\_\_ Zip \_\_\_\_\_

**THE AMERICAN RADIO RELAY LEAGUE**  
 225 MAIN ST.  
 NEWINGTON, CT 06111



# BROADCAST TOPIX

BY MARK MANUCY, W3GMG

## DX, NEWS AND VIEWS OF AM AND FM BROADCASTING

As I write this column I am near St. Augustine, Florida, getting caught up on all the new stations in and around Florida since I was here last. As I prepared by DX list I was amazed at the number of new stations that are on the air. The Florida population has tripled since I moved north 15 years ago, so one would expect the radio station population to expand as well. There are stations in towns that a few years ago didn't even have a 7-11 store! Well, not to complain; the more stations to log, the better I like it! I picked up quite a few driving from Baltimore. I have my son (11) interested in using the scan-search on the auto radio to log stations while enroute. This is a nice way to get a youngster started in DXing. He sets the radio (AM, then FM) to one end of the dial, then pushes the search button, logging each frequency the scan stops on as he advances from one end to the other. Now the trick will be to get him to check the guide book to figure out which stations he heard. One step at a time! The Boy Scout Radio merit badge will help! I've logged so many stations up and down I-95 between New York and Miami that I only have to catch the new ones that come on the air.

Last month I gave you a simplified circuit for an "S meter" that could be added to a radio. A car radio is what I had in mind, but it may be used with any radio to which one would like to add a metering circuit.

This month's circuit is the finished version of the circuit that has now been tested over the road for several thousand miles. My particular meter is a 50 microampere unit, which is adjusted to read 50 on the strongest FM signal, and the strongest AM signal drives it to about 47 on the scale. Driving at night through the Carolinas, WNBC (Wolfman Jack) and several others constantly showed signals of 40-42 on the meter. The scale of the meter could be changed to show anything one desired from 1 to 5 (SINPO) or 1 to 9 and 60 dB over 9 for "S" units. With a 50 reading at the top I guess I could drop the "0" on the end and call it 0 to 5. Just bear in mind my intention is not an accurate microvolt meter but a meter to compare strengths of different stations. This is of course dependent on the receiver circuitry. Some receivers will produce a greater AGC voltage at one end or the other of the dial so would not be accurate for any purpose other than having a meter move upscale.

The static level is greater in Florida than what I am accustomed to in Maryland at this time of year, but it's still fun to be able to hear a local channel or 1 kW daytimer several hundred miles up the coast, when they are normally heard for only 20 or 30 miles. This gets me back to our continuing discussion of the best DX location. The sea coast is a great



Two Clovis, New Mexico stations, KWKA (AM) and KTQM (FM), depending on which way you're going! (Photos courtesy of Bill and Mary Stegemann)

location, however, the other considerations of humidity and salt air corrosion leads me to just want to visit these locations rather than live there. My jury is still out though! What are your thoughts?

In the July, 1984 issue we printed a map showing the conductivity of the United States. If you're interested in finding a great DX location for retirement or just living, you might want to look this issue up.

### Mail Call

One of the fun parts of writing this column is reading all the interesting mail that comes to the editor. This month was no exception. John Creque has several interesting questions. I'll take his last one first.

He is looking to upgrade his receiver and was rummaging through some old ARRL handbooks, spotting an SX-73. John, al-

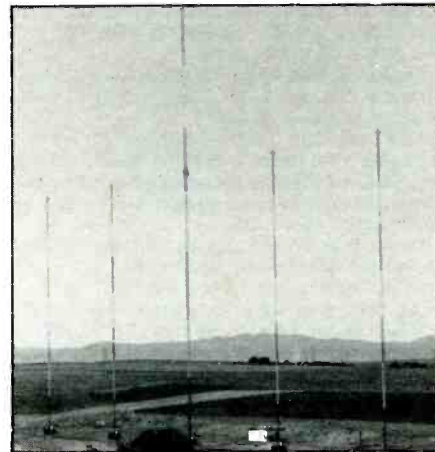

From its Denver location, KEZW is heard almost to Russia over the North Pole. They use 5 towers at night and the single 2 section collinear tower in the daytime. (Photo courtesy of Pat Griffith)



Radio Gong 2000, 96.3 MHz in Munich, West Germany, uses this as their logo.

though these were grand receivers, as were the SX-62, SX88, and others, they are not of the quality of the same type of receiver today. However, you should be able to get one of these "oldies but goodies" for a good price. An important consideration is the condition of such a receiver. If you get it for a good price, chances are the condition will not be A-1. This means that a lot of work will be necessary to replace components that have gone bad many years earlier. Some of the parts that may have expired will not be easy to replace since they are no longer



made. If you are a cracker jack repair person, then this becomes a challenge. If you are not, then it becomes expensive! For the same amount of money, one may purchase a new solid-state receiver, either of the portable variety or of the desk top variety. The portables will run from \$100 to about \$300 and the desk top from about \$250 to whatever you want to pay. The ICOM R-71A and the Kenwood R-2000 are in the upper end of the desk top variety.

John's other question is about the loops we talked about a few months ago. He lives about 75 miles from Detroit and wants to hear stations on 950 kHz other than WWJ. A loop antenna (any, not just mine) is directional and will allow one to null a signal from a certain direction. This will permit the signals from the broadsides of the loop to be heard. Noise from a powerline may also be nulled. The loop has a figure "8" pattern so it will only do one thing. But please don't expect miracles.

I have had several requests concerning trading airchecks, and these are being sent to all the interested parties via a common mail list so that they may be in touch with each other. If you are interested, drop me a letter explaining and include an SASE.

Bud Stacey caught another RPU not long ago. WTVN, Columbus, Ohio uses 26.250 MHz. Bud was using a CB 5/8 whip with his Yaesu FRG-7700—another desk top receiver (see Bud's photos).

Bill and Mary Stegemann have combined hobbies . . . listening and photography. He's



been DXing since he was 12 years old, and she helps with the picture taking. Bill says DXing of AM and FM is poor in SE New Mexico, so make a note of that for places not to settle for the best DX locations. It looks like a station in Clovis, New Mexico, bought an old theatre to use for their studios. On one side of the marquee is the FM call (KTQM—with tower in background) and the other side of the marquee has the AM call, KWKA.

Boomer, as he calls himself, and several of his friends operate a "mobile listening post" in Illinois. They recently logged KGA in Spokane, and according to Boomer's letter were quite excited about getting their letter of reception.

Radio Marti is on everyone's mind lately, not just DXers. If you have listened for

Radio Marti, it would be an interesting catch. They operate from the Florida Keys near Marathon with a directional antenna beamed toward Cuba. Their operation on 1180 kHz is, as of this writing, from about 5:30 a.m. to approximately 7:30 p.m. using 50,000 watts. It'll be a good catch since they are directional with probably 150 kW ERP toward Cuba. With the salt water path between the Keys and Cuba, it's going to be difficult to jam that signal. I understand the attempts have been unsuccessful.

Patrick Griffith sent a newspaper clipping from a Denver, Colorado paper, *Rocky Mountain News*, with a story of KEZW being heard on a semi-regular basis near Helsinki, Finland. One of the towns hearing KEZW was six miles from the Soviet border. To take advantage of the publicity, the station ran a

## Call Letter Changes

Old	New	Location
<b>AM Stations</b>		
KOIT	KXLR	San Francisco, CA
KTRT	KKMK	Truckee, CA
KNDE	KVIS	Visalia, CA
KUAD	KFSC	Windsor, CO
WWCM	WSDM	Brazil, IN
WLTS	WYAT	New Orleans, LA
WLQV	WCZY	Detroit, MI
WJW	WRMR	Cleveland, OH
new	WKDJ	Hughesville, PA
WWBR	WBEM	Windber, PA
WKGE	WDAR	Darlington, SC
KSGA	KUEN	Wenatchee, WA
<b>FM Stations</b>		
WMKM	WSOS	St. Augustine, FL
WKSJ	WWWQ	Columbia City, IN
WBDJ-FM	WSDM-FM	Brazil, IN
WABH	WESQ	Camden, ME
WCZY	WCZY-FM	Detroit, MI
WUUN	WRUP	Marquette, MI
KBMO-FM	KSCR	Benson, MN
KXSS	KJUS	Lincoln, NE
WBFR	WFBF	Buffalo, NY
WPJB-FM	WWLI	Providence, RI
WORG-FM	WORG	Orangesburg, SC
KXYL-FM	KISJ-FM	Brownwood, TX
KFOX-FM	KFFQ	Llano, TX
KIXK	KFQX-FM	Merkel, TX
KFRZ-FM	WSEX-FM	Brigham City, UT
WSCW-FM	WJYP	S. Charleston, WV

## UNIVERSAL SHORTWAVE CATALOG



70 PAGES!

- SEE WHAT'S NEW IN . . .
- \* COMMUNICATIONS RECEIVERS
  - \* PORTABLE SHORTWAVE RADIOS
  - \* ANTENNAS & SUPPLIES
  - \* RADIOTELETYPE EQUIPMENT
  - \* COMMUNICATIONS BOOKS
  - \* PARTS & ACCESSORIES

Send \$1.00 (or 3 IRCs) REFUNDABLE.

### UNIVERSAL SHORTWAVE RADIO

1280 Alda Drive  
Reynoldsburg, Ohio 43068  
Phone: 614-866-4267

Please send all reader inquiries directly.

"Great Signal Search Contest" dealing with radio trivia. The winner was to get a week-long trip for two to Leningrad! The winner should be able to feel right at home, however, by tuning in KEZW at night! See the enclosed photo of KEZW. Pat also enclosed a cassette of the tests at the new TIS station on 530 kHz at the Denver airport.

### AM Stereo

This month I report two new Kahn stations and five new C-Quam stations (see Table 1).

There are new AM stereo stations coming on the air all the time, however, the consumer is also interested in the other new electronic gadgets as well. The most recent is the portable compact disk player, which has been introduced by Sony and others. The CD is also available in automobiles as well. Until the radio station provides programming that is of more interest to the public than what is available via the disk or tape medium, the radio audience will not grow beyond where it is now.

The AM Stereo stations I've been hearing around the country have really sounded good. Last night my family stopped to eat in Ocala, Florida, and I got my trusty Sony SRF-A100 out and listened to WOCA and WFUC, which were using the C-Quam system. Of all the stations I've heard, the stereo stations always sound better even in mono because they have taken the trouble to improve their audio quality. Let's hope this will create additional competition for the rest of the stations.

### FM

Over the past few months FM Stereo has had some exciting news of its own. When stereo was first introduced to FM in the sixties, the owners/managers were anxious to have anything to help their stations earn a few extra bucks. FM did not excite anyone except those who enjoyed classical music and maybe a few college stations. Stereo records were new at the time, so when FM Stereo became a possibility, the stations did not mind having their coverage cut to 25% in order to gain some listeners. Now that FM has more listeners than AM, you might imagine the excitement of the owners/managers to find the NAB has found a way to gain back the coverage lost to the implementation of stereo. While this may not mean a whole lot to the DXer, it does mean greater coverage for each stereo station implementing this new FMX stereo system.

If you are a DXer who hunts up subcarriers on FM sidebands, I will have another one for this type of DXer to find. This new FMX technology does not change the current FM stereo means of broadcasting, so there is no additional loss to the mono listener, or the current stereo listener either. The FMX adds a second pilot carrier at 9.3 Hz and a quadrature modulated signal on the 38 kHz subcarrier. The second signal is compressed and reference to the original difference signal (L-R). The end result when decoded at the receiver is equal coverage to

Table 1

Call	City	Freq	Power	Sys
KHYV	Modesto, CA	970	1.0/1.0	C
KJCB	Lafayette, LA	770	1.0/1.0	K
WHYN	Springfield, MA	560	5.0/1.0	C
WYAM	Meridian, MS	1240	1.0/1.0	C
WPTR	Albany, NY	1540	50/50	C
KORD	Tri-Cities, WA	870	10/.25	K

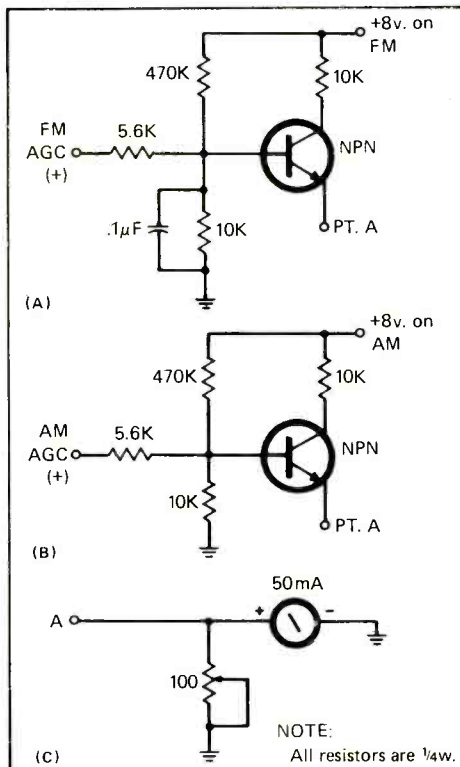

Schematic diagram for AM and FM signal strength meter using single meter.

the mono signal of the station before converting to stereo.

I guess the most exciting part of the FMX system is the low cost of implementation. The consumer will have maybe \$3 added to the cost of the receiver while the station will probably have to pay no more than several thousand. That amount of money to quadruple your coverage area is peanuts. Look for this FMX system to be available within the next year.

Speaking of the FM audience as I was a moment ago, according to a spring report from NBC Radio Research, the FM listeners are now just over 70% versus 30% for AM. The only place AM holds a lead still is in the 50+ age group (55% to 45%). The largest AM audiences are 6 to 10 a.m. 37% (versus FM's 63%) and 12 midnight to 6 a.m., where AM has only 32% of the audience. Of the 12 to 24 year age group, 90% listen to FM.

That's about 30 for this time. Your cards and letters are getting better all the time, not to mention the good photos of late. Write for information on using your Commodore 64 to assist in logging (include an SASE) and for \$2.50 postpaid I'll send the most recent update on all the AM Stereo stations. The address for all is P.O. Box 5624, Baltimore, MD 21210.

PC

### Station Updates

Call	Location	Freq	Pwr	Ant
<b>AM</b>				
WDDD	Johnson City, IL	810	- / 25	DA-N
WNUY	Mims, FL	840	.25/0	O
KIEV	Glendale, CA	870	10/-	DA-2
KIKR	Conroe, TX	880	1/1	DA-N
WCBF	Seffner, FL	1010	50/10	DA-2
KMBR	Lincoln, NE	1130	50/5	DA-2
KNED	McAlester, OK	1150	1/0	O
WCGC	Belmont, NC	1270	5/-	DA-2
WJBR	Wilmington, DE	1290	2.5/0	O
WWKY	Winchester, KY	1380	2.5/0	O
WYSH	Clinton, TN	1380	- / 5	DA-N
WISA	Isabella, PR	1390	- / 1	-
KJCK	Junction City, KA	1420	- / 5	DA-N
WKBJ	Milan, TN	1600	2.5/0	O
<b>FM</b>				
KEFR	Le Grand, CA	89.9	2.2	1950'
WEPR	Greenville, SC	90.1	85	1184'
KBZE	Agana, Guam	97.5	N/C	485'
KCMX-FM	Ashland, OR	101.9	32	1426'
WHEW	Ft. Myers, FL	101.9	100	992'
WLUM-FM	Milwaukee, WI	102.1	2.0	325'
WUUN	Marquette, MI	103.3	100	515'

KEY: D = Daytime, N = Nighttime, DA = Directional Antenna, DA1 = Same Pattern Day & Night, DA2 = Different Pattern/Power Day/Night, O = Omni Antenna Day and/or Night



# WASHINGTON PULSE

## FCC ACTIONS AFFECTING COMMUNICATIONS

### **\$2,000 Notice Of Apparent Liability Issued To Amateur**

A Notice of Apparent Liability to Monetary Forfeiture for \$2,000 has been issued to James Brantley of Los Angeles, California. Brantley, K6KPS, is an Advanced Class Amateur operator.

The Commission received complaints from amateurs over a long period of time that Brantley was disrupting their communications. Most recently there were complaints that Brantley had been disrupting communications on the 20 meter band. Brantley would call "CQ" for long periods or make calls to nonexistent stations, which had the effect of occupying the frequency and disrupting communications of other amateurs who were using the frequency.

On December 19, 1984, Commission personnel observed Brantley on several 20 meter amateur frequencies making lengthy "CQ" calls and calls which purported to be attempts to establish contact with other amateur stations. Some of the stations called do not exist. He did not establish communications with any station, not even with two stations which made numerous attempts to respond to his CQ calls. It was evident that the purpose of these transmissions was merely to occupy the frequencies and thereby disrupt normal communications. Other stations on the frequencies complained of the disruption and requested Brantley to move, but he ignored these requests.

Brantley was cited for violating Section 97.113 of the Amateur Rules. That rule prohibits "broadcasting" in the Amateur Radio Service. The Amateur Radio rules in general permit point-to-point communications between and among individual stations; "broadcasting" involves communications which are not directed to a particular station. The Commission considered that prolonged calls, calls to non-existent stations, and refusal to establish communications when his calls were answered constituted operation in violation of the broadcasting prohibition.

### **FCC Zeros In On Bootleg "Oscar" Network**

The FCC high frequency direction finding network has identified a group of unlicensed radio operators violating the Commission's Rules. These operators have been identifying themselves as "The Oscar Group." They normally operate on 6930 and 6933 kHz. These frequencies have been assigned to International Fixed and Land Mobile Radio Services in the U.S.

On June 8, 1985, the first step in a series of planned enforcement actions was taken. Unlicensed radio operator, Clinton E. Ber-

ger, Ridgetop, Tennessee, was located by the Atlanta District Office, during unlicensed communications with other Oscar Group Members. A fine of \$1,000 has been issued to Mr. Berger.

Other cities targeted for concentrated enforcement by the Commission's Field Operations Bureau are Indianapolis, Indiana, and San Francisco, California.

Unlicensed radio operators involved with the "Oscar Group" would probably be wise to voluntarily stop their activities. Failure to do so could result in severe penalties. The July '85 POP'COMM contained a story about the outbreak of bootleg networks, including some on ham frequencies.

### **Radio Jammers Arrested**

Engineers from the FCC's Detroit District Office, using mobile radio direction finders, conducted an enforcement campaign in the Detroit, Michigan, metropolitan area against illegal radio jamming of a local amateur repeater. This investigation was initiated as a result of numerous complaints from ham radio operators about deliberate interference to their communications in the Amateur Radio Service (ARS). The Amateurs provide voluntary public service on these frequencies for such programs as Sky Warn Tornado Watch and the Radio Civil Emergency Service (RACES).

Criminal complaints were filed on May 7, 1985, against three of the five operators. U.S. Marshals, in conjunction with the U.S. Attorney for the Eastern District of Michigan, arrested Glenn L. Barrick, Detroit; Richard Szabo, Farmington Hills; and Robert J. King, Redford Township. Barrick and Szabo were charged with operating on ARS frequencies without a license, and King with operating contrary to Commission rules.

Two other operators involved in the deliberate interference were Keith Morin of Southgate, who received a \$750 Notice of Apparent Liability for unlicensed operation, and Bernie B. Slotnick of Harbor Springs, who received an Official Notice of Violation, looking toward possible revocation or suspension of his Advanced Class Amateur License or imposition of an administrative forfeiture up to \$5,000.

Pending the filing of formal charges against the individuals involved, the criminal complaints were later dismissed by the U.S. Attorney for the Eastern District of Michigan.

Dismissal of the criminal complaints allows the cases to be processed in a more routine manner. Upon complete review of the case information, the results may be presented to a federal grand jury to seek indictments for the violation of Federal law. Conviction could result in a possible maximum

sentence of one year imprisonment and a \$10,000 fine for each offense.

The Federal Communications Commission's Detroit District Office conducted the investigation and located the illegal operators in response to numerous complaints about deliberate interference being caused to Amateur Radio communications.

### **Coast Stations To Transmit Medical Advice To Ships**

The Commission adopted new rules which allow limited (private) coast stations to provide medical advisory service to ships at sea.

By this action, limited coast stations can apply to the Commission for a license to operate on frequencies between 2030 and 27,500 kHz to communicate with vessels regarding medical matters. Specific frequencies will be assigned to each licensee after coordination with the U.S. Government Interdepartment Radio Advisory Committee.

The action came in response to a petition from Medical Advisory Systems, Inc. (MAS), a limited coast station which provides medical advisory service on a contractual basis, operating under a developmental authorization. MAS provides routine medical advice, as well as emergency procedures, and coordinates medical evacuations when necessary.

### **Partial Reconsideration Of Amateur Rulemaking Dismissal Granted**

The Commission has granted a Petition for Partial Reconsideration filed on February 21, 1985, which sought to reverse, in part, FCC action dismissing a rulemaking proposal by Gordon Girton on September 7, 1984.

Girton's petition sought six specific changes to the amateur volunteer examination program. One of these changes was to allow Advanced Class licensees to administer examination Elements 1(B) and 4(A). Reconsideration of the FCC's decision not to allow Advanced Class administration of Element 1(B) was sought.

The petitioner argued that the Commission was incorrect in an earlier determination that Advanced Class examiners are precluded from administering Element 1(B) and also urged that Advanced Class volunteer examiners are needed to increase the efficacy of the volunteer examination program.

While the Commission held that there is no statutory bar to administration of Element 1(B) by Advanced operators, it disagreed there is a shortage of amateur examiners or examination opportunities which would warrant the addition of more examiners at this time.

## NEW AND EXCITING TELEPHONE TECHNOLOGY

### New Services And New Numbers

**T**he world is literally at your fingertips with your telephone. Many numbers throughout the country may be dialed free of charge through the use of the 800 dialing system. You can also select which way you want a call routed, and through which service. Depending on your telephone communication needs, several alternatives are available for long distance and interstate calling. This month we'll take a look at those "secret numbers" as well as alternatives to the regular long distance service.

By the way, those "secret numbers," such as automatic ring-back numbers, vary from city to city throughout the country. The easiest way to find out what these very private numbers are would be to simply ask your local telephone installer—you know, the person who is seen with a white hard hat and a gaggle of tools suspended on a belt. These men and women normally have private numbers on the tip of their tongue, and it's no skin off their nose if they give you the numbers to play around with (or so I have been told).

There are several useful telephone numbers that can be used for testing your phone and phone line, getting the latest news on what is happening in the telephone business, or accessing your alternative long distance carrier (Other Common Carrier—OCC) with a toll free call.

The Other Common Carriers (OCCs) are instituting toll free access numbers throughout the U.S., so if you are away from home or the office you only have to remember one number; if you call from a pay phone, you either get your money back or don't have to insert a coin in the first place, depending on your phone company. Beside the phone numbers are the "800" customer service numbers that you can call with questions about the 950 numbers or even order service if you are not already a subscriber (See Table 1).

Each phone company has a toll free news line telling you what is happening with your phone company—its stock price and latest application to the Utilities Commission for a rate hike—and a few will tell you the weather as well. Some of these numbers, although they are long distance calls, can be accessed with no toll charge thanks to the wonders of Computerized Exchanges (Electronic Switching Systems—ESS—Central Offices)—(See Table 2).

All phone companies have test numbers, but they tend to vary from Central Office to Central Office and from Company to Company. I can't give any specific numbers, but

**Table 1**

Allnet	950-0444	800-982-8888
AT&T	950-0288	800-222-0300
GTE Sprint	950-0777	800-521-4949
ITT	950-0488	800-526-3000
MCI	950-0222	800-624-2222
RCI	950-0211	800-458-7000
SBS - Skyline	950-0888	800-235-2001
USTel	950-0333	800-527-4105
Western Union	950-0220	800-235-5303

**Table 2**

Pacific Telephone "News Line"	213-621-4141
	800-522-1077
	800-882-1061
General Telephone News	800-322-0111
Michigan Bell News	313-223-7223

will give a list of the type of tests that are available. The best way to get these numbers is to ask a friendly phone man.

The most wanted number is the "Ring Back" number. This number will call back your phone after you hang it up to test the ringers. Some companies also use the same number for testing TouchTone™ pads, so you dial in 1 through #. If your pad is working properly, you will hear a series of beeps come down the line after you dial the #. If you then flash the hook switch and hang up your phone, it will start ringing!

"Number verification" is a very useful number, especially if you are working on an installation that has several lines. You dial the verification number and a synthesized voice will tell you what the number of that line is.

"Silent termination" is a number that connects you to a resistive pad and will help prove whether you have a noisy phone or line. Yes, some phones produce noise or static on the line!

"Busy test" will give you a busy tone when you dial it. You may not have much use for this number unless you are someone who is tired of giving out your phone number. Give someone this one and they will know you are popular!

"Battery switch" reverses the polarity of your line about once per second with a rhythmic clicking. This will test a phone and its dial to see if it is polarity sensitive.

Many phone companies switch off their test numbers during evenings and weekends. Also because of the harassment potential of the ring back number, it tends to be changed frequently.

As the U.S. is moving toward equal access, there is a test number that will tell you what company you have chosen or been assigned for your long distance service. Dial 700-555-4141. A recording will come on the line and say something like: "You have reached the AT&T Long Distance Network. Thank you for choosing AT&T."

### Equal Access

For about a year now, telephone companies have been converting their exchanges to allow subscribers "Equal Access." The purpose of equal access is to make it as easy to dial an alternative long distance carrier as it is to dial long distance via AT&T.

Old Ma Bell still carries most of the long distance traffic, and even MCI, the biggest of the alternative carriers, only has six percent of the long distance market. Sprint, who is number two in the discount market, has two percent of the long distance business. The alternates think that the reason AT&T has the hog's share of the market is that it is difficult to use an alternate carrier. To dial a long distance carrier, you have to dial 24 digits plus wait for access tones, remember your access code, etc. To dial long distance anywhere in the U.S. via AT&T, you dial no more than 11 digits.

AT&T is convenient with unequaled service. The alternates are inconvenient but cheaper than AT&T. Corner grocery stores were convenient with good service. Supermarkets are cheaper but less easy to use. Supermarkets took over from the corner grocery store without complaining to the FCC and demanding legislation to make them



**Table 3**  
**Long Distance Ten Triple X Numbers**

ALLNET	10-444
AT&T	10-288
ITT	10-488
MCI	10-222
RCI	10-211
SBS	10-888
Sprint	10-777
USTel	10-333
Western Union	10-220

These numbers will be listed in your local phone directory when your area has equal access.

The XXX digits are the same as the last three digits of the 950 access numbers.

easier to use, and they did it with lower prices and greater variety.

When equal access is offered by the local phone company, subscribers will be able to choose between about nine long distance companies, including AT&T as the primary carrier. That means if Sprint is selected as the primary carrier, a long distance number dialed the old fashioned way—1-(XXX) XXX-XXXX—will be routed via Sprint.

Ma Bell services and other long distance carriers will still be available to the subscriber after dialing an access code, as will all other alternate carriers. To access carriers other than the primary carrier, dial 10 XXX (XXX) XXX-XXXX. The long distance carriers call these the "Ten Triple X Access Codes" (see Table 3). There will be no extra charge from Ma Bell for using her services, such as operator assistance, even if AT&T is not the primary carrier.

Staying with Ma Bell means nothing will change at the subscribers end. The same high quality lines, credit for bad connections, and operator assisted calls by dialing the same old way. The low cost carriers do not provide these services and do not bill as precisely as AT&T.

When equal access is available, a subscriber who is currently using AT&T for most of his long distance calls and Sprint or MCI for the rest may maintain AT&T as his primary carrier and continue to use the alternative services when required by dialing 10-XXX first.

As each area goes over to equal access, the local phone company will send out a questionnaire asking subscribers to choose a long distance carrier. If the subscriber does not choose a carrier, he may lose AT&T as his primary carrier and be assigned to one of the discount carriers. The local phone company will not assume that a subscriber who does not let them know what carrier he wants is happy with his current AT&T service and does not want to change. This assumption was made in the past, but the discount carriers complained to the FCC. Now, non-responding subscribers are assigned a carrier on a proportional basis.

The largest discount carrier, MCI, has been at the forefront of getting legislation changed to make life easier for the long distance services. Their corporate headquarters is in Washington, DC, not because that is where they keep their equipment, but because that is where they keep their lawyers. The growth of MCI has been led by litigation and legislation, not engineering. MCI recently merged with IBM, who also owns two thirds of SBS-Skyline. This will undoubtedly keep MCI the largest discount carrier, and they intend to have ten percent of the long distance market by 1986. IBM has purchased 15% of MCI and can buy up to 30% of MCI without MCI board approval. In the next six months, IBM will buy out Aetna's partnership in SBS and the SBS and MCI customer bases will merge. AT&T and IBM seem to be fighting for each other's territory—AT&T wants the computer market and IBM wants the telecommunications market. These are two giants that want a piece of your phone bill and all of your data processing.

Sprint is a long distance carrier that was founded by Southern Pacific Railroad, which sold it to GTE. GTE makes telephone equipment (automatic electric and general cable), prints directories, owns local phone companies, manufactures semiconductors, and now handles long distance. When Ma Bell did all these things, the legislators screamed monopoly and Judge Greene broke up AT&T; yet no one murmured when GTE recently purchased Sprint. The argument could be made that GTE is not as big as AT&T, but they could be. They are now as vertically integrated as Ma Bell was in her heyday.

The overseas market is the latest territory to be attacked by the discount long distance carriers. Both MCI and Sprint offer overseas service and service to Canada. MCI has agreements with 27 countries (see Table 4) and has two percent of the overseas market. Sprint serves 16 overseas countries (see Table 5). Although discount carriers have routes overseas and the government owned phone systems in those countries use MCI and Sprint equipment to route calls into the

**Table 4**  
**Overseas Countries Served By MCI**

Algeria	Malawi
Argentina	New Zealand
Australia	Oman
Belgium	Papua New Guinea
Brazil	Qatar
Canada	Senegal
Cyprus	South Africa
East Germany	Sri Lanka
Egypt	Taiwan
Great Britain	Tanzania
Greece	Thailand
Jordan	Tunisia
Kenya	United Arab Emirates
Kuwait	

**Table 5**  
**Overseas Countries Served By Sprint**

Argentina
Australia
Bangladesh
Botswana
Canada
Chile
East Germany
Egypt
Great Britain
Guam
Malawi
New Zealand
Papua New Guinea
Tanzania
Thailand
United Arab Emirates

This is not a complete listing. New countries are continually being added. Check with the carriers for the latest countries.

U.S., the overseas subscribers are neither offered a discount on their overseas call charges or informed that their overseas calls may be routed by a discount carrier. AT&T covers every country in the world that has phone service, including Pitcairn Island, which only has one telephone.

The choice is yours!

**CB MODIFICATIONS**

Increase channels, range, privacy! We specialize in frequency expanders, speech processors, FM converters, PLL & slider tricks, how-to books, plans, kits. Expert mail-in repairs & conversions. 16-page catalog \$2.

CBC INTERNATIONAL, P.O. BOX 31500P,  
PHOENIX, AZ 85046 (602) 996-8700

**COMPUTER**  
**TRADER**  
**MAGAZINE**

\*\*\* LIMITED TIME OFFER \*\*\*  
**BAKER'S DOZEN SPECIAL!**

**\$12.00 for 13 Issues**

Regular Subscription \$15.00 Year

Foreign Subscription: \$55.00 (air mail)  
\$35.00 (surface)

Articles on MOST Home Computers, HAM Radio, hardware & software reviews, programs, computer languages and construction, plus much more!!!

Classified Ads for Computer & Ham Radio Equipment

**FREE CLASSIFIED ADS**

for subscribers

Excellent Display and Classified Ad Rates  
Full National Coverage

**CHET LAMBERT, W4WDR**

1704 Sam Drive • Birmingham, AL 35235  
(205) 854-0271

Sample Copy \$2.50

CIRCLE 22 ON READER SERVICE CARD

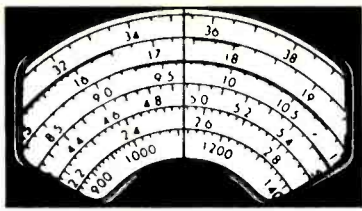

# COMMUNICATIONS CONFIDENTIAL

BY MIKE CHABAK

## YOUR GUIDE TO SHORTWAVE "UTILITY" STATIONS

As this is the November issue, I trust that you have been checking out the stations covered in the last two previous CommCo columns. If propagation conditions are, as anticipated, better this season, then many of you have already chalked up a number of stations that we previously discussed.

My vantage point for writing this column was back in July, and the four month differential doesn't permit me to comment on how this fall/winter season's propagation aspects are currently panning out. All I can say is, if you've been unsuccessful so far in monitoring Antarctica and other stations discussed, keep trying, for you have the remainder of the winter and early spring ahead of you.

This month we'll look at a few more general utility areas and specific stations that seem to pop out of the woodwork this time of the year.

### 2 MHz Marine Band

One of the casualties of the summer months is the 2 MHz marine band. Unless you live in close proximity to one of our coasts, attempting to monitor these stations is a losing battle to thunderstorm QRN and less than ideal summer propagation conditions. The winter season gives even an interior state/province monitor the opportunity to monitor 2 MHz marine activity in coastal areas of the Atlantic, Pacific, Gulf, Great Lakes, and the Northwest Territory waters of Canada.

The 2 MHz marine band is the domain of the local marine operator stations. They deal with vessels close into their shores, whereas their big brothers—the high seas marine stations—work ships far out to sea. Local marine stations primarily handle ships that are in the vicinity of the port areas that they serve. A good deal of the traffic is in the form of the ship/shore radiotelephone variety. During daylight hours, the bulk of these comms involve privately owned pleasure craft. After dark, this dwindles away to primarily freighters, tankers, tugs, liners, and occasional naval vessels.

Unless you live no more than 100 miles from the shore areas, daytime monitoring of the 2 MHz band is a waste of time and effort. The reason for this is the "D" ion layer. It forms at sunrise and remains ionized until sunset. Its ionization activity is such that any frequency below 4 MHz is all but absorbed by the D layer. Hence, only very short range comms are possible during the local area's daytime hours. After local sunset, the D



VR1C's QSL was a back-door way of getting a QSL from a USCG Loran station. VR1C was on Makin Atoll in the Gilbert Islands several years ago. (Courtesy Tom Kneitel)

layer molecules recombine, rendering the layer transparent to these lower HF radio frequencies. After dark, the 2 MHz signals can reach the higher F2 layer, and therefore will propagate over thousands of miles. Any of you who are BCB DXers know what I mean. To be sure, these conditions exist during summer, but during the summer months the F2 layer is more energetic, presenting a less than ideal refractive surface. Combine this with thunderstorm QRN, and for the inland monitor, even nighttime monitoring of the 2 MHz marine band is frustrating. Hence, the nighttime winter months afford the most ideal conditions to check out the lower HF frequencies.

Even as such, many inland utes never really bother to scan the 2 MHz band, primarily out of the belief that you're too far away from the coast. It is true you often won't encounter 5 by 5 comms, but the coastal areas can be heard. My experience in Colorado, supported by numerous QSLs, proves that both ship and shore stations as far away as the Atlantic seaboard are easily receivable.

Ship/shore comms are not the only thing to be heard. Some shore stations transmit weather and marine information, and scattered throughout the 2 MHz band are frequencies used by the U.S. Coast Guard and the U.S. Navy. Therefore, there is ample opportunity to log private, commercial, and military ship/shore stations.

All 2 MHz marine stations operate in the voice mode, primarily USB. The USCG and USN, in addition to voice, utilize RTTY. The first list is of marine operator stations. They are listed alphabetically by city name, call letters, and the frequencies they transmit on. The frequencies in parentheses are the duplex ship transmit frequencies. Simplex comms are also carried out, and this will be indicated by the word "simplex" following the shore station frequency.

### 2 MHz MARINE OPERATOR LIST (BY CITY NAME)

Location	Call	Shore/Ship Freq
Astoria OR	KFX	2442/2009 kHz
	KFX	2598/2206
Atlanta GA	WAN	2450/2366
Baltimore MD	WMH	2400/2400
Boston MA	WOU	2450/2366
	WOU	2506/2406
	WOU	2566/2390
Buffalo NY	WBL	2514/2118
	WBL	2550/2158
	WBL	2582/2206
Charleston/Savannah SC	WJO	2566/2390
Coos Bay OR	KTJ	2566/2031.5
Corpus Christi TX	KCC	2538/2142
Delcambre LA	KGN	2506/2458
Eureka CA	KOE	2450/2003
	KOE	2506/2406
Galveston TX	KQP	2450/2366
	KQP	2530/2134
Honolulu HI	KBP	2530/2134
Jacksonville FL	WNJ	2566/2390
Jeffersonville IN	WJN	2782/2782
Memphis TN	WJG	2086/2086
	WJG	2782/2782
Miami FL	WDR	2442/2406
	WDR	2490/2031.5
	WDR	2514/2118
Mobile AL	WLO	2572/2430
New Orleans LA	WAK	2482/2382
	WAK	2558/2166
	WAK	2598/2206
New York NY	WOX	2482/2382
	WOX	2522/2126
	WOX	2590/2198
Norfolk VA	WGB	2450/2366
	WGB	2538/2142
Ocean Gate NJ	WAQ	2558/2166
Pittsburgh PA	WCM	2086/2086
	WCM	2782/2782
Ponce Playa PR	KRV	2585/2086
Rogers City MI	WLC	2514/2128
	WLC	2550/2158
	WLC	2582/2206
San Francisco CA	KLH	2450/2003
	KLH	2506/2406
San Juan PR	WCT	2530/2134
San Pedro/Los Angeles CA	KOU	2466/2382
	KOU	2522/2126
	KOU	2566/2009
	KOU	2598/2206
Seattle WA	KOW	2482/2430
	KOW	2522/2126
St Louis MO	WKG	2086/2086
	WKG	2782/2782
St Thomas VI	WFA	2506/2009
Tampa FL	WFA	2466/2009
	WFA	2550/2158
Wilmington DE	WLF	2558/2166

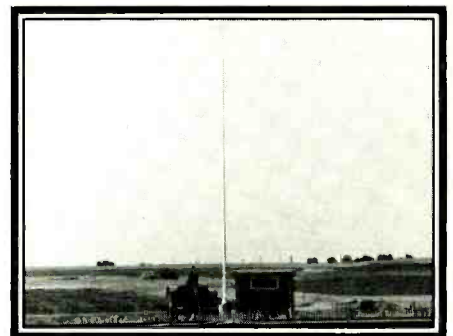

Patrick W. Griffith, Denver, Colorado, sent along this photo of TIS station KNID798 at Denver's Stapleton Airport. The station operates on 530 kHz.



**N ATLANTIC NETWORK**  
(ACTUALLY E COAST ATLANTIC)  
Even though many of the stations can use landline, it's surprising, considering their close locations, that few utes report their HF activity.

NMA7 Jupiter FL NMN33 Carolina Beach NC  
NMF32 Nantucket MA NOL Bermuda  
NMF33 Caribou ME VDB Cape Race NFLD

Frequencies:  
2413 kHz (all but VDB)  
3256 (all but NMA7 NMN73 and NOL)  
4048.5  
5313  
7377.5 (all but VDB)  
9278.5  
11513.5

**ALEUTIAN NETWORK**  
NMJ22 Attu Island, Aleutians  
NRW2 St Paul Island, Pribilof Islands  
NRW3 Port Clarence AK  
NOJ USCG KODIAK (not a Loran site but as area Comsta, does occasionally show up in the net)  
Frequencies: 2748 2809 4531 4575 5226 5317 5422 5745 6812 6935 6945 7441 9073 10368.5 12150 kHz

**HAWAIIAN/CENTRAL PACIFIC NETWORK**  
NR0 Johnston Island  
NR05 Upolu Point HI  
NR07 Kure Island  
NMO USCG Honolulu (not a Loran site but does show up on the net)  
Frequencies: 4050 5063 7473 9303 9630 12205 kHz

**NORWEGIAN SEA NETWORK**  
Most stations operated by the host nation, with USCG personnel at some of the sites. This net rarely reported (if ever) in North America.  
DML Sylt Island, FRG  
JXL Bo, Norway  
JXP Jan Mayan Island, Norway  
NMS Shetland Island, England  
OUN Ejde, Denmark  
OYV Angissog, Greenland  
TFR Sandur, Iceland  
TFR2 Keflavik, Iceland  
VDB Cape Race, NFLD, Canada  
VDB2 St Anthony, NFLD, Canada  
Frequencies:  
3607 (all except VDB/VDB2)  
4857.5  
7512.5  
7717.5 (only JXL JXP NMS OUN OYV)  
10337.5  
13707 (only VDB VDB2 OYV)  
13423 (all except VDB/VDB2)

**MEDITERRANEAN NETWORK**  
Voice frequencies difficult to monitor in N America. All stations USCG staffed.  
AOB50 Estartit, Spain  
NCI Sellia Marina, Italy  
NCI3 Lampedusa, Italy  
NCI4 Kargabaran, Turkey  
NCI10 Rhodes, Greece  
Only 3 freqs are used by all stations, the remainder range from 2 to 4. An asterisk (\*) indicates all the station frequencies. Mailing addresses of these USCG Loran stations can be found in Speedy SRGU.  
Frequencies: 3625.5 3798 5066\* 5123 6943.5 7441 8021.5 8111\* 9396 9474\* 10333.6 10938.5 10958.5 13665.5 15723 16044.5 18963 20262.5 22823 24088.5 26825 kHz

**2 MHz MARINE BAND (BY FREQUENCY)**

Shore	Ship	Station/Area/Use
2003	2003	USCG Gt Lakes Unskd Marine Info BC
2082.5	2082.5	USCG Cutter/Ship All areas ex-Gt Lakes
2086	2086	WJG/WCM/WGK
2093	2093	USCG Cutter/Ship All areas ex-Gt Lakes
2103.5	2103.5	USCG Intra-station use
2142	2142	W Coast Areas
2150	2150	USN Harbor Control
2182	2182	International Calling/Distress Freq
2203	2203	USCG Cutter/Ship Gulf of Mexico
2230	2203	USCG 8th Dist (New Orleans) Opns
2261	2261	USCG Air/Ground - CONUS only
2400	2400	WMH
2442	2009	KFX
2442	2406	WDR
2450	2003	KOE/KLH
2450	2366	WAN/WOU/KQP/WGB
2466	2009	WFA
2466	2382	KOU
2482	2382	WAK/WOX
2490	2031.5	WDR
2506	2009	WAH
2506	2406	WOU/KOE/KLH
2506	2458	KGN
2512	2512	USCG Cutter/Ship - Alaska
2514	2118	WBL/WDR/WLC
2522	2126	WOX/KOU/KOW
2530	2134	KQP/KBP/WCT
2538	2142	KCC/WGB
2550	2158	WBL/WLC/WFA
2558	2166	WAK/WAQ/WLF
2566	2009	KOU
2566	2390	WJO/WOU/WNJ
2572	2430	WLO
2582	2206	WBL/WLC
2585	2086	KRV
2590	2198	WOX
2598	2206	KFX/WAK/KOU
2638	2638	USCG All areas - Unskd Marine Safety BC
2659	2659	USCG 12th Dist (San Francisco) Opns
2662	2662	USCG 3rd Dist (New York) Opns
2667	2667	USCG Intra-station use
2670	2670	USCG Marine Information BC
2675	2675	USCG 5th/11th Dist (Portsmouth/Long Beach) Opns
2683	2683	USCG 8th/14th Dist (New Orleans/Honolulu) Opns
2691	2691	USCG 7th Dist (Miami) Opns
2694	2694	USCG 1st/13th Dist (Boston/Long Beach) Opns
2699	2699	USCG 8th/13th Dist (New Orleans/Seattle) Opns
2702	2702	USCG 5th/14th Dist (Portsmouth/Honolulu) Opns
2707	2707	USCG 1st/13th Dist (Boston/Miami) Opns
2710	2710	USCG 11th Dist (Long Beach) Opns
2716	2716	USN Harbor Control
2738	2738	USCG Cutter/Ship All areas ex-Gulf and Gt Lakes
2748	2748	USCG 17th Dist (Alaska) Opns
2782	2782	WFN/WJG/WCM/WGK
2830	2830	USCG Cutter/Ship All areas ex-Gt Lakes
2836	2836	USN Harbor Control

Note that 2003 2082.5 2093 2203 2512 and 2738 can have ship/ship, USCG Cutter/ship, and when required, shore/ship comms. USCG Dist opns include any/all CG shore stations within that district plus CG cutters in the vicinity.

**CANADIAN 2 MHz MARINE (BY FREQUENCY)**

Shore	Ship	Station
1630	1630	VAC Comox BC
		VAF Alert NWT
		VAG Bull Harbour NWT
		VAH Sandspit BC
		VAK Victoria BC
2054	2054	VAC Comox BC
		VAE Tofino BC
		VAG Bull Harbour NWT
		VAH Sandspit BC
		VAI Vancouver BC
		VAJ Prince Rupert BC
		VAK Victoria NC
2182	2182	Int'l Calling/Distress
2458	2340	VAE Tofino BC
		VAK Victoria BC
2514	2118	VCD Riviere-du-Loup PQ
		VCF Mont Joli PQ
		VCG Riviere-du-Renard PQ
		VCK Sept Iles PQ
		VCM Saint Anthony NFLD
		VCN Grindstone PQ
		VCP Saint Lawrence NFLD
		VCS Halifax NS
		VFN Montreal PQ
2530	2815	VON Saint John's NFLD
		VCA Charlo NS
		VAX Cansoletown PEI
		VCO Sydney NS
2538	2142	VAU Yarmouth NS
		VON Saint John's NFLD
		V00 Comfort Cove NFLD
2558	2142	VFA Inuvik NWT
		VFC Cambridge Bay NWT
2582	2206	VAL Inoncdjouac PQ
		VAP Churchill MAN
		VAR Saint John NB
		VAU Yarmouth NS
		VAV Poste-de-la Baleine PQ
		VAW Killinek PQ
		VAX Canso NS
		VCA CharLottetown PEI
		VCC Quebec PQ
		VCG Riviere-du-Loup PQ
		VCK Sept Iles PQ
		VCM Saint Anthony NFLD
		VCN Grindstone PQ
		VCO Sydney NS
		VCP Saint Lawrence NFLD
		VCS Sydney NS
		VFF Frobisher Bay NWT
		VFR Resolute Bay NWT
		VFU Coral Harbour NWT
		VFJ Goose Bay LAB
		VOJ Stephenville NFLD
		VOK Cartwright LAB
		VON Saint John's NFLD
		V00 Comfort Cove NFLD
2598	2598	Marine info and traffic lists

All stations ID by name followed by "COAST GUARD RADIO." As required, Quebec stations can conduct comms in English or French. Virtually any station may turn up on 2598 kHz with marine weather, mariners' info, or traffic lists.

The 2 MHz marine shore stations (excluding USCG/USN) identify by city port name, followed by the words "marine operator." The bulk of marine operator comms are in the duplex mode. Certain stations also have a simplex working frequency, but for the most part, simplex comms are assigned to specific geographical areas. In these area assignments, it is possible to hear ship to ship comms, too. The USCG and USN voice comms are all simplex mode (on 2 MHz).

A second list shows the overall ship/shore frequency/station layout.

Some frequencies of interest include the following.

The frequency 2182 kHz is the International Calling and Distress voice frequency. Normally you can hear a USCG shore station announcing an upcoming marine information broadcast on 2182 kHz; that will shortly commence on 2670 kHz. Ships may also make initial contact with a shore station on 2182 kHz, then be referred to the station's normal working frequency.

Any ship in distress will utilize the voice frequency of 2182 to announce their emergency. This will be replied to by any ship/shore station that monitors it. If the stricken vessel cannot transmit/receive on any other frequency, 2182 kHz will be maintained as the prime working frequency. In any event, the USCG will become involved.

The frequency 2670 kHz USB is the USCG marine information broadcast frequency. It is much like that heard on the USCG 4-6-8-13 MHz frequencies, but will be of a more local area scope rather than high seas. In addition to hearing the major USCG Comm/RadStas, you will hear many smaller CG facilities that transmit marine information only on 2670 kHz. So this frequency will allow you to log a USCG station not normally encountered on the higher HF frequencies.

On the other 2 MHz USCG frequencies, you can hear ship/shore and ship/ship comms between CG shore and cutters, and other ships.

The U.S. Navy frequencies of 2150, 2716, and 2836 kHz are used for naval harbor control duties. Voice traffic will either be in the clear, with naval vessels giving their actual names and shore stations, the harbor name plus the word "control," or it can be of a tactical nature. If tactical, the USN will make use of alpha numeric call signs and other obscure calls to insure that you cannot identify either the ship or shore station.

A third list, shown by frequency assignment, covers the Canadian 2 MHz stations. All ID by name and the words "Coast Guard Radio."

The frequency 2598 kHz serves the same purpose as the USCG 2670 kHz marine information channel.

## 2 MHz Monitoring Tips

The most important thing to remember is the local sunrise/sunset conditions. If, for example, you live in Kansas, you can try for Atlantic and Gulf Coast stations up until the local sunrise at those coastal locations. Just

after sunrise, comms will begin a steady fade out, and by roughly (plus) 30 minutes, no longer will you be able to hear those locations east of you.

If you're trying for Pacific coast stations, you must do so *before your local sunrise*. The formation of the D layer above you will prevent 2 MHz signals from the west penetrating down to your location. So plan your 2 MHz monitoring accordingly.

It is to be noted that throughout the 2 MHz band, you will hear many Spanish language stations. These are Mexican, Cuban, and can include those in Central America and northern South America.

As these 2 MHz activities are of the utility gender, except for scheduled marine information broadcasts, all of the rest will be catch-as-catch-can. You can either roam back and forth throughout the 2 MHz band, check out selected frequencies, or camp out on one specific frequency. Whatever method you choose, patience is the key factor. During winter, late evenings to pre-dawn, it is normal to expect to hear stations at least 1,000 miles away. When propagation conditions are very good, coast to coast will be possible. But remember that most 2 MHz stations are not high powered, so except for close in, don't expect 5 by 5 voice levels.

## DX EDGE

While we're on the subject of day/night conditions, it would be wise to once again mention a very handy tool to aid in this determination. Called the DX EDGE, it is offered by several shortwave radio outlets and publishing firms. Basically the DX EDGE is a plastic affair—a base map of the world and 12 transparent overlays (one for each month). The overlays have a local time scale on top, which you align with your location's longitude. Each overlay has both a clear and transparent red dotted area, denoting day/night. At a glance you can see which parts of the earth are in day or night, respective to your location. By shifting the overlay

around, you can determine time periods, which places both you and your area of interest in darkness or light.

It's simple, easy to use, and a genuine asset for seeing at a glance, or predicting day/night conditions around the world in respect to your location. By applying the basic utility knowledge that higher HF frequencies are utilized in daytime and lower HF nighttime, it will (as the trademark name implies) give you an edge.

## Commercial Aeronautical

Anyone who dabbles in air traffic control/enroute aircraft comms knows that certain areas of the world are much better heard in North America during the winter. In fact, some are only to be expected to be heard here during the winter months.

Time versus frequency is an important factor. Establish the local time period for the geographical area you wish to monitor. Usually the most ideal conditions will be when both you and that area are in darkness, yet similar conditions will exist in daylight and the period either side of sunrise/sunset.

ATC locations in daylight will be using 17-13 or 11 MHz frequencies. Early evening sees 13-11-10 and 8 MHz coming into play. Deeper into night, 11-8-6 and 5 MHz, then afterwards until dawn, 6-5-4-3 and 2 MHz will be the primary frequency areas. Daily propagation and interference conditions will decide the primary and secondary frequencies for any given time period. Fortunately, they are often announced during comms, so once you latch on to a primary frequency, you can merely sit back and wait for comms to occur.

We'll examine the following major air route areas that are somewhat removed from the western hemisphere and the commonly heard North Atlantic/North Pacific air routes.

- (EUR) Europe—all of Europe as far east as Moscow, including the Middle East and Northern Africa



The advisory sign for KNID798 would make a great king-sized QSL card. (Photo by Patrick Griffith)

- (MID) Middle East—all of the Middle East, south through NE Africa/north to Moscow, then south and east to India
- (AFI) Africa—all of Africa, Indian Ocean area to Mauritius, north then east through Middle East, and Atlantic to the Azores/Cape Verde Islands
- (INO) Indian Ocean—SE and western Australia to India, west to eastern Africa, down through to eastern South Africa and east to western Australia
- (SEA) South East Asia—Australia to India, then east across SE Asian mainland to Taiwan, the Philippines and south through New Guinea to Australia
- (SP) South Pacific—eastern Australia to Nauru, then east below the equator past Tahiti (including Hawaii to Tahiti)
- (CWP) Central Western Pacific—Hawaii west to Japan/Korea, south through coastal China, the Philippines, New Guinea, the Solomons and back to Hawaii encompassing all island groups north of the equator

Table 1 is a listing of frequency assignments for the mentioned ATC areas, arranged in a descending frequency order from 17 to 2 MHz.

From a North American vantage point, Indian Ocean traffic will be the most difficult to hear, followed by the Middle East and

Rare interior photo of the FAA's "Denver Center" ARTCC station located at Longmont, Colorado. This center controls air traffic in a 286,000 square mile zone. (Photo by Patrick Griffith)

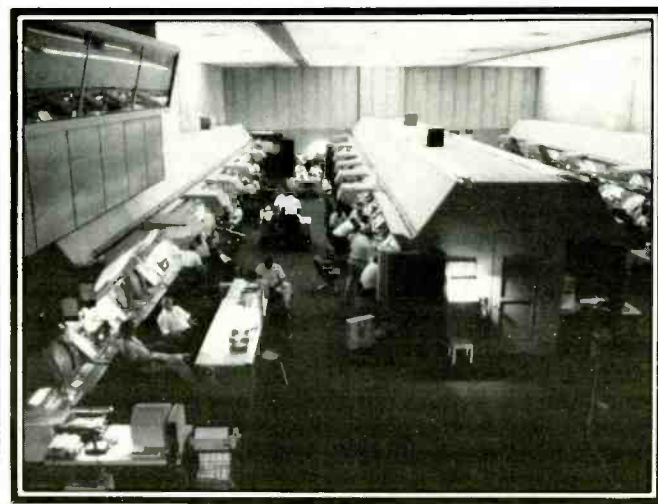

Table 1

EUR	MID	AFI	INO	SEA	SP	CWP
17961	17961	17961	17961	17907	17904	17904
13288	13312	13294	13306	13318	13300	13300
10084	13288	13288	8879	13309	11327	11384
6598	11375	13273	5655	11396	10084	10081
5661	10018	11330	5634	10066	8867	8903
3479	8951	11300	3476	8942	5643	6562
	8918	8903		6556	5559	6532
	6631	8894		5655	3467	5661
	6625	6673		5649		5652
	5667	6574		3485		4666
	5658	6559		3470		3455
	4669	5658				2998
	3473	5652				
	3467	5493				
	2992	4657				
	2944	3467				
		3425				
		3419				
		2878				
		2851				





Europe. You'll note that some of the allocated frequencies are assigned to more than one area. As not all global areas are depicted here, don't be surprised to hear ATC air/ground comms from areas not shown in this breakdown on certain frequencies.

## Diego Garcia

The U.S. Navy has a facility in the Indian Ocean on the British Chagos Archipelago island of Diego Garcia. The U.S. Naval call letters are NKW.

Diego Garcia became well known to the public following the Iranian takeover of the U.S. embassy in Tehran. It occupies a somewhat strategic position in the Indian Ocean, and has steadily become an important base from which the U.S. monitors Soviet naval activity in the region.

Presently, there are two verifiable means to monitor Diego. One is its USN MARS outlet; the other is via its military ATC facility. The USN MARS callsign is NNNONRS, and has been heard in voice mode (USB) on 13974.0 and 20623.0 kHz. Other possible USN MARS frequencies to watch are: 13826, 14383.5, 16298.5, 20936, 20987, and 20997 kHz USB/RTTY.

"Diego Tower" is the voice ident it uses for ATC duties. Three main types of U.S. aircraft frequent Diego Garcia. Usually there is a detachment of Navy P-3 Orion long range patrol aircraft on temporary duty. They will all use a tactical callsign series, normally of

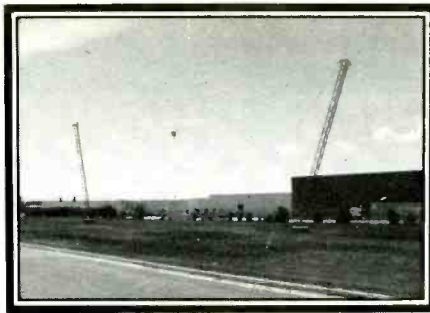

Some of the HF antennas at "Denver Center." (Photo by Patrick Griffith)

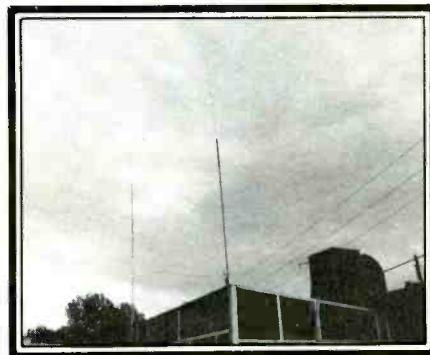

The receiving antennas used by Patrick Griffith at his Denver station. These antennas feed into a Kenwood R-2000 and MFJ 1020A preamp-tuner.

two letters and three numbers. When a U.S. aircraft carrier is in the vicinity, COD transports can shuttle back and forth between island and carrier. They will often use the carrier wing designated call letters.

A more easily identifiable group are the USAF MAC transports (C-5 and C-141 types), hauling in men and material.

A third group of visitors are USAF SAC B-52s and dedicated reconnaissance configured aircraft. The B-52 bombers in the Indian Ocean are mainly being utilized in a long range maritime recon role, a role in which the USAF and USN also cooperate in in other areas of the world.

The frequencies Diego Tower has been heard on are: 11176, 11234, and 23227 kHz USB voice. The best time to hear Diego on the 11 MHz frequencies will be in the few hours before your local sunset/sunrise. The frequency 23227 kHz is quite difficult, since daylight conditions will have to exist between your QTH and Diego. For North American areas, this will be only for eastern seaboard monitors, just after local sunrise. One must remember that Diego Garcia, from the vantage point of the state of Colorado, is exactly on the opposite side of the earth. Hence, when it's day here, it's night there, and vice versa, so you'll appreciate that the available time line monitoring windows are quite narrow, and it will also require good propagation conditions to hear it in North America. For those of you who do monitor Diego Garcia, here are mailing addresses to use. Use one of the two headers (\*). \*USN MARS Station NNNONRS (or) \*USNAVCOMMSTA—NKW (for Die-

go Tower comms), followed by: FPO San Francisco, CA 96685.

## Thule/Incirlik

You USAF buffs are familiar with the major GCCS stations the likes of MacDill, Scott, Hickam, McClellan, and so on. Probably the two most difficult GCCS stations to monitor from North America are those at Thule, Greenland and Incirlik, Turkey.

Thule Airbase is located on the western coast of Greenland above 75 north latitude. It has to be about as far out in the sticks as the USAF could find. Its primary purpose is to man and maintain one of the three giant BMEWS radar sites (Ballistic Missile Early Warning System), which make up an integral part of our ground based early warning network. MAC aircraft supply the base, but air traffic in and out of Thule is infrequent. To liven things up a bit, there are occasional Navy P-3 Orions patrolling Baffin Bay/Davis Strait and other less readily identifiable military aircraft, all who can use the Thule GCCS radio facilities when required.

The best time to try for Thule will be from around your local sunset to dawn. Frequencies to watch are: 5710, 6738, 8967, 11228, and 13201 kHz USB voice. This time of the year, Thule is in twilight to total darkness, as the sun isn't getting above their horizon. So the 5-6-8 MHz frequencies are the best to check out.

Incirlik Airbase is located in southern Turkey. It is difficult to hear in North America because of the time wise distance versus frequency and that comm activities are far less active from this GCCS station. Monitoring time lines would be from your local sunset through evening hours on 6738 and 11176 kHz. Just after your local dawn, try on 13215 and 15015 kHz.

Both Thule and Incirlik rebroadcast the USAF SAC Skyking messages. As these are considered classified transmissions, there isn't much point to indicating their times. But they do serve a very useful purpose, allowing one to ascertain if Thule/Incirlik are audible on frequency during a given time period. These rebroadcasts are made on all assigned frequencies.

Thule—(plus) 28 minutes after the hour

Incirlik—(plus) 18 minutes after the hour

Remember—use these transmissions only for QSA references. Do not send in a reception report on them.

If you do log comms other than these rebroadcasts, try the following addresses:

Thule Airbase Communications  
APO New York, NY 09023-5000

Incirlik Airbase Communications  
APO New York, NY 09289

## Number Transmissions

I have a request from a numbers buff for some very peculiar information, which he hopes certain CommCo readers can help him out with. This is only for those of you who live in the coastal locations of Texas,

## MISSING



NAME: Stewart Wade Beam DOB: 2/28/78 Age: 7  
EYES: Blue HAIR: Blonde DATE MISSING: 11/25/81  
FROM: Gallatin, IL. CHILD FIND #2371P



NAME: Daniel Metzger DOB: 10/6/80 Age: 5 EYES:  
Brown HAIR: Brown DATE MISSING: 6/14/84  
FROM: Latham, IL. CHILD FIND #2354P

If you can assist in identifying a child or if you are one of these missing children, call Child Find Inc..

**TOLL FREE HOTLINE (800)-1-AM-LOST**  
(914-255-1848 collect in NY). Please refer to the Child Find # when calling.





Teun Feldman of the Netherlands snapped this photo of a floating emergency radio used by large ocean-going vessels. It probably operates on 500 and 8364 kHz CW as well as 2182 kHz and other voice frequencies.

Louisiana, Alabama, Georgia, and Florida. You are asked to check out 3090 and 4030 kHz AM mode (on the hour to plus 15 minutes), during your local 11 a.m. to 1 p.m. time period. That's correct . . . bracketing your local noon hour!

You are asked to report if you hear the SS/YL 5-digit number transmissions (she repeats "Atencion" plus 5 or 6 numbers in a s/on session which lasts for 3 to 4 minutes; this is followed by 5-digit groups of numbers. Transmission ends with "Final, Final"). If possible, check on various days and report, even if you *did not* hear them. Whether you did or not, please send your observations, via this column, giving basic day, time, and frequency data, and if heard, approximate signal strength. Bizarre I must admit, but your assistance will be greatly appreciated.

### Time Division Transmissions

Back in the June 85 CommCo column's "Intercept" section, "Old Sarge" reported a logging which he described as a "time division scrambled" type on 14563 kHz.

POP\*COMM reader R.F. Heard has sent along this explanation:

... What was actually heard was use of time and frequency redundancy (such as that of the 6028 series modem). Before the signal is transmitted, the already encrypted signal is applied to the modem. The modem outputs 7 multiplexed 170 Hz shift RTTY signals centered at 850-1190-1530-1870-2210-2550 and 2890 Hz. Each is a copy of the input signal, hence frequency redundancy. However, there is a one second lag

between the channels. A character first appears on 1530 Hz, repeats one second later on 2890, then on 850, 1870, 2550, 1190, and finally on 2210 Hz (hence time redundancy). Thus each character appears on each of the 7 RTTY frequencies at different times. All of this is not for additional security (as each channel is a copy of the input), but rather is to insure correct reception of the message. The frequency redundancy provides protection against interference and the time redundancy protects against total signal loss for up to three seconds. This mode is in use by various U.S. government agencies including the military . . ."

With this explanation, I hope the CommCo readers have a better understanding of this type of RTTY transmission.

### Sideband Tuning AM Signals

Reader R.F. Heard also provided comments on determining transmission mode and applications for tuning an AM mode transmission in SSB.

Standard AM is a double sideband transmission with full carrier. Reasons for transmitting in the AM mode are simplicity and to provide a broader audio range. Just check out a local AM station in AM and then in USB mode when they are playing a musical selection, and you'll understand what I mean by a broader audio range.

While you are doing so, notice (in AM mode) how wide the signal bandwidth is. Including splash over, it can extend 5 kHz on either side of its assigned frequency.

Standard single sideband mode eliminates one of the sidebands (they're both identical) plus the carrier. This allows for a much narrower bandwidth usage, usually on the order of 1.4 or 1.5 kHz.

Some transmissions utilize what is sometimes referred to as compatible AM. This is a USB transmission with a reduced or full carrier (RCSSB or FCSSB). This permits the transmission to be monitored in either AM or USB modes.

Some utility stations use this approach, and when you tune into one, there are clues to indicate this. With your receiver in the AM mode, the signal's audio quality may be poor, but when you switch over to USB (and retune if necessary), the audio quality is much better. Then switch to LSB (and retune if necessary). If the transmission is employing USB with carrier, you will not hear anything on the LSB side. If you do, it will be a poorly modulated AM mode transmission. By the way, almost all RC/FCSSB transmissions use USB, not LSB.

A standard suppressed carrier SSB transmission is easily identifiable. Its voice audio is clear when you're in the SSB mode, and when you nudge the dial slightly up or down frequency, the voice will dissolve into what sounds like Donald Duck. But (and if the transmitter is within its SSB parameters) you will not hear any background hum when you shift the dial. If the transmission is employing a carrier insertion, then even the slightest movement of the tuning dial will

## UNSCRAMBLERS

For Police, Fire & Emergency Channels

Satisfaction Guaranteed

Write or Call

501-623-6027

DNE, Inc. Rt. 7, Box 257-C  
Hot Springs, AR 71901

CIRCLE 146 ON READER SERVICE CARD

## ROCKY MOUNTAIN SHORTWAVE SPECIALISTS

Low Discount Prices On

Kenwood, Yaesu, Sony, Panasonic, ICOM, Uniden, NRD-515, MFJ, Bearcat, Regency, Info-Tech, B&W, and Antennas, Books, Accessories  
Send \$1 for catalog.

Allied Appliance & Radio

4253 South Broadway  
Englewood, Colorado 80110  
Phone 303-761-7305

Please send all reader inquiries directly.

ATTACH LABEL HERE

PLEASE PRINT

NEW ADDRESS HERE

NAME \_\_\_\_\_

ADDRESS \_\_\_\_\_

CITY \_\_\_\_\_ STATE \_\_\_\_\_

DATE \_\_\_\_\_ ZIP \_\_\_\_\_

POPULAR COMMUNICATIONS

76 N. Broadway,  
Hicksville, NY 11801

POPULAR COMMUNICATIONS

76 N. Broadway,  
Hicksville, NY 11801

**SUBSCRIBER SERVICE**

**CHANGE OF ADDRESS**

Planning to move? Please let us know six weeks in advance so you won't miss a single issue of POPULAR COMMUNICATIONS

Attach old label and print new address in space provided. Also include your mailing label whenever you write concerning your subscription to insure prompt service on your inquiry

**POPULAR COMMUNICATIONS**  
76 N. Broadway,  
Hicksville, NY 11801





Remember that just Voice, MCW, and CW transmissions (including FSK Morse) are to be forwarded to this column. Other types of signals are to be separately mailed to the column editor for that particular subject, i.e. Broadcast, RTTY, Scanner, etc.

Typewritten entries are preferable, but legible hand printed loggings are fine also. Please write plainly. I hate to say this, but if I can't read the information, there is only one place it will end up—and you all know where that is.

Submit your list of items in ascending frequency order and it will be very much appreciated if you would leave some unused lines between your entries. This facilitates the separation of selected items for sorting by frequency for preparation of the final version.

While sifting through the intercepts, I have learned that some of you have some very long antennas. To date, the longest one I have seen mentioned was a 450 foot long-wire reported in use by Peter Goubeaud of Tennessee. That's a lot of wire!

Reader Tom Adams, Wisconsin reported a fouled-up transmission at 2122 on 21.4 kHz. He observed NSS (US Naval Radio, Washington DC) sending 5-letter groups in CW. Adams advises this is unusual because the USN longwave/VLF stations normally only transmit FSK Teletypewriter signals. It would appear that someone on duty at the station noticed the goof because the CW transmission was abruptly discontinued and replaced by FSK RTTY. Thanks for your comments, Tom.

And now for this month's loggings.

- 124:** CKN Vancouver Forces Radio, BC, Canada. CW call tape at 0130. (Tom Adams, WI)
- 194:** TUK Nantucket Airport, MA. CW at 2251. (Gary Vendetti, NJ)
- 206:** GLS Galveston, TX. MCW ID and WX on Voice at 0400. (Robert Homuth, AZ)
- 230:** ILT Albuquerque, NM. MCW ID and WX on Voice at 0500. (Homuth, AZ)
- 236:** GNI Grand Isle, LA. MCW ID and Voice with notification to aircraft of military exercises in the Gulf of Mexico at 0600. (Homuth, AZ)
- 242:** EL El Paso, TX. MCW ID and WX on Voice at 1100. (Homuth, AZ)
- 251:** RPY Blythe, CA. WX on Voice at 1200. (Homuth, AZ)
- 304:** Nashville, TN. Voice station giving WX conditions for Aviation in TN, KY, NC, AL, MO. Station also announced "High speed Military Training Advisory for below 10,000 feet within 100 nautical miles of Nashville and Knoxville" at 0040. (Peter Goubeaud, TN)
- 317:** SWA Swan Island aero beacon with CW call tape at unspecified time. (Stanley Cramer, NY)
- 325:** CM Cape May, NJ. CW at 1624. (Vendetti, NJ)
- 326:** PQO Phoenix, AZ. WX and notice to pilots on Voice. Heard throughout 24 hours. (Homuth, AZ)
- 329:** AQD Hartford, CT. CW beacon at 0536. (Hank Lukas, NY)
- 330:** RYN Tucson, AZ. Ryan Airport. Simulcasts with PQO. (Homuth, AZ)
- 344:** FCH Fresno, CA. MCW ID and WX on Voice at 0400. (Homuth, AZ)
- 350:** RG Oklahoma City, OK. WX on Voice at 0630. (Homuth, AZ)
- 362:** EZB Oakland, CA. MCW ID at 0300. (Homuth, AZ)
- 365:** FT Fort Worth, TX. MCW ID and WX on Voice at 0600. (Homuth, AZ)
- 375:** ZIN Bahamas. CW at 0321. (Vendetti, NJ)
- 379:** GKQ Newark, NJ. CW beacon at 1832. (Lukas, NY)
- 394:** ENZ Nogales, AZ. WX on Voice at 0600. (Homuth, AZ)

- 396:** ZBB Bimini, Bahamas. Heard as early as 0100. (Homuth, AZ)
- 500:** XFM Manzanillo, Mexico with VVV marker at 0400. (Homuth, AZ)
- 517:** YMA Petawa, ON, Canada. CW beacon at 0552. (Lukas, NY)
- 530:** WNAG556 Coronado, CA. EE/YL giving traffic conditions for Coronado area on 24 hours per day basis. The station QSL's rapidly and even though it only runs 6.5 watts, it can be heard up to 20 miles away on ground-wave. Address for reception reports is city of Coronado Police Department, 578 Orange Ave., Coronado, CA 92118. (Thanks to Robert Homuth, CA for this information.)

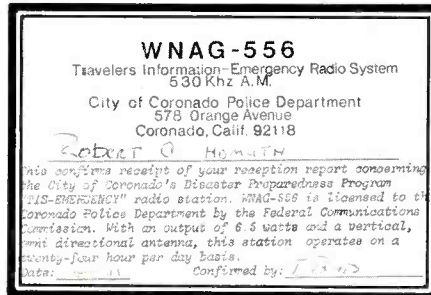

- 2670:** NMW Astoria, OR. USB Voice with Notice to Mariners at 0534. (Mike Chinakos, WA)
- 2716:** US Navy ships Halsey, Tuesdale, Cushing, and Wadsworth working San Diego Harbor Control on USB Voice at 1333. (Glenn Lynd, CA)
- 3860:** W3NAM Goddard Space Center. Retransmission of Space Shuttle Challenger and SkyLab in SSB at 2100. This is a club station. (Lukas, NY)
- 4080:** SS/YL 5-digit groups at 0440. (Shirley Lieb, IL)
- 4292:** XYR6 Rangoon, Burma in CW with call tape at 0140. (Cramer, NY)
- 4467:** KIJ960 Civil Air Patrol, Southeast Region in SSB Voice at 0200. (Lukas, NY)
- 4500:** VNG, Lindhurst Victoria, Australia. Time Signals at 0950. (Conrad Durocher, TX)
- 5000:** ZUO Olifantsfontein, South Africa. Call sent three times followed by time (all in MCW) at 0430. (Homuth, AZ)
- 5333.8:** FOXTROT TANGO, LIMA FIVE, JULIET FOUR INDIA, and UNIT FOUR all involved with military-type radio checks in USB Voice at 0446. (Hall, CA)
- 5900:** SS/YL 5-digit groups at 0620. (Tim Magrann, CA)
- 6100:** YVTO Caracas, Venezuela. Time Signals at 0720. (Durocher, TX)
- 6218.6:** US Coast Guard at Portsmouth, VA in USB Voice talking to Cutters and Aircraft at unspecified time. (Jim Rosenbluth, Washington, DC)
- 6676:** Sydney, Bangkok, and Singapore VOLMET stations heard 1400-1420. (Homuth, AZ)
- 6679:** Honolulu, Hong Kong and Auckland NZ VOLMET stations heard 1235-1320. (Homuth, AZ)
- 6691.9:** Polovsk, Magadan, and Okhotsk (all in East Siberia) in USB Voice with 5-digit groups and Russian PT traffic at 0730. (Hall, CA)
- 6712:** KENOSHA working CRYSTAL BEACH in USB Voice with tactical military traffic at 0430. (Cramer, NY)
- 6750:** SEVEN ALPHA ONE, Edmonton Military Radio, Canada passing WX and cargo information. Off at 0452. (Jeff Bowers, OH)
- 6761:** MARIGOLD and RIOTGUN (probably SAC activity) on USB Voice at 2300. (Ted Moran, IL)
- 6774:** SS/YL 5-digit groups at 0610. (Robert Sheaffer, CA)
- 6802:** SS/YL 4-digit groups at 2310. (Moran, IL)
- 6835:** SS/YL 5-digit groups at 0900. (Don Benn, Victoria, BC, Canada)
- 7426:** SS/YL 5-digit groups at 0405 and 0505. (Lieb, IL)
- 7430:** SS/YL 5-digit groups at 0430. (Lieb, IL)
- 7434:** 5-digit groups in CW at 0215. (Don Mussell, KY)
- 7438:** CCS Santiago Naval Radio, Chile. FSK Morse call tape at 0425. (Homuth, AZ)
- 7445:** EE/YL repeating KILO PAPA OSCAR TWO over and over at 0315. (Lieb, IL)
- 7600:** HD210A Guayaquil, Ecuador. Time Signals at 0710. (Durocher, TX)
- 7604:** EE/YL repeating VICTOR LIMA BRAVO TWO in AM Voice at 0145. (Cramer, NY)
- 8115:** SS/YL 5-digit station at 0603. (Chinakos, WA)
- 8148:** OVG8 Danish Navy Frederikshaven, Denmark

- with CW call tape at 0045. (Jerry Brumm, IL)
- 8340:** Unidentified station sending 3-letter groups at 1955. (Magrann, CA)
- 8400:** Chinese/YL with 4-digit groups. Heard almost daily at 1400, 1500 and sometimes at 0700 and 0900. Sign-on and sign-off always with music. (Sheaffer, CA)
- 8422:** Unknown Oriental language/YL with what appeared to be 5-digit groups. (Sheaffer, CA)
- 8470:** XFL Mazatlan, Mexico in CW at 0043. (Lukas, NY)
- 8520:** PPO Olinda, Brazil in CW at 2244. (Lukas, NY)
- 8550.7:** CTP95 Oeiras Naval Radio, Portugal in CW at 2319. (Vendetti, NJ)
- 8618:** ED24 Aranjuez, Spain in CW at 1844. (Lukas, NY)
- 8644.2:** Sand F Beacons in CW at 0500. (Borcher, CA)
- 8645.5:** P Beacon in CW at 0505. (Borcher, CA)
- 8645.7:** D Beacon in CW at 0503. (Borcher, CA)
- 8646.8:** K Beacon in CW at 0508. (Borcher, CA)
- 8647.2:** Z Beacon in CW at 0512. (Borcher, CA)
- 8765:** National Weather Service, Honolulu in USB Voice with offshore WX broadcast at 0556. (Chinakos, WA)
- 8784:** JEB18 Bern Maritime Radio, Switzerland in SSB at 2145. (Lukas, NY)
- 8828:** Aukland, NZ VOLMET in USB Voice at 0650. (Steven Johnson, NE)
- 10060:** CW Time pulse every two seconds, very weak. Not synchronized with WWV when observed at 1600. (Homuth, AZ)
- 10141:** SBC46 Cyprus. Voice announcement "This is Cyprus Radio, Radio Telephone Maritime Service" at 2242. (Nacht, NY)
- 10184.3:** SZNB (Greece allocation) in CW with 5-digit groups (Zero sent out as T) at 0455. (Borcher, CA)
- 10243.9:** SS/YL 5-digit groups in AM Voice at 0532. (Borcher, CA)
- 10642.2:** F Beacon in CW at 0533. (Borcher, CA)
- 10642.7:** D Beacon in CW at 0535. (Borcher, CA)
- 10814.6:** NIBX, 5BGD, Q88C, 5AM1, MW0Z (possibly unidentified military training net) in CW with message repetition requests, QSA queries, etc. at 0538. (Borcher, CA)
- 11290.4:** X Beacon in CW. Irregular keying as if hand sent. F Beacon heard very weak on same frequency at 1840. (Borcher, CA)
- 12235:** SS/YL 5-digit groups on AM Voice at 1905. (Moran, IL)
- 12746:** VVC Calcutta, India with Time Signals on CW at 2253. (Moran, IL)
- 12780.5:** YUR Riejeka, Yugoslavia in CW at 2252. (Vendetti, NJ)
- 12800.9:** PAH Istanbul, Turkey in CW at 2255. (Vendetti, NJ)
- 13046:** PZN Paramaribo, Suriname in CW w/CQ marker at 2041. (Lingenfield, VA)
- 13300:** US Coast Guard station Honolulu in USB Voice at 0447. (Johnson, NE)
- 13453.6:** 5BGD (unidentified, see 10814.6 entry) in CW calling at 0609. (Borcher, CA)
- 13634.7:** C Beacon in CW at 1935. (Borcher, CA)
- 13635.6:** D Beacon in CW at 1937. (Borcher, CA)
- 13636:** K Beacon in CW at 1939. (Borcher, CA)
- 13672:** 6MK56 (Republic of Korea allocation) in CW with call tape which indicates transmission is YONHAP NEWS SERVICE at 0659. (Borcher, CA)
- 13766:** 3MA26 Tapei ROC in CW with QRA tape at 0550. (Borcher, CA)
- 14670:** CHU Ottawa Ontario, Canada with time signals at 1800. (Durocher, TX)
- 16590:** KHT Cedar Rapids, IA in USB Voice w/ship-to-shore traffic at 1440. (Lingenfield, VA)
- 17010:** TAH Istanbul, Turkey in CW w/CW marker at 2301. (Lingenfield, VA)
- 17027:** OST16 Oostende, Belgium in CW at 1551. (Vendetti, NJ)
- 17068:** OX28 Lyngby, Denmark in CW at 1553. (Vendetti, NJ)
- 18620:** EE/YL 3/2-digit groups at 1900. (Moran, IL)
- 20191:** AFE70 Cape Radio, Florida in LSB Voice with conversations relating to NASA operations at 1730. (Moran, IL)

*Don Schimmel has a broad background in communications, which he gained over a 40 year span that includes 30 years of combined military and government service. His initial SW hobby interest was in SW Broadcasting Stations but then gradually shifted to the Utility field. Being semi-retired, he is able to devote many hours to monitoring and also does some writing for publications.*

## Beaming In (from page 4)

corded voice that talks to you. Yet there are few who would wonder what you were really up to.

You might even have a wild sports car that sounds like a B-1 bomber as it roars down the street and causes pedestrians to climb the lamp poles in order to get out of your way. This could well make you the most popular attraction to arrive at the local hamburger joint's parking lot on a Saturday night.

Not so with electronics hobbyists.

When you were a kid, you had granny walking around muttering to herself how all of those "electrical contraptions are someday going to blow us all to Kingdom Come." And as you got older, you realized that even folks whose hobby was chess had a better chance at meeting members of the opposite sex than you did while you were sitting at home surrounded by all of your microchips and meters.

If you're lucky, your neighbors won't find out that you've got a transmitter and accuse you of deliberately jamming their TV reception, being a spy, or listening in on their private conversations.

A scanner in your possession will surely bring up questions of your motives and what mischief you might be planning. A radar detector raises even more suspicions among

the general populace. On the other hand, being a computernik causes people to regard you as having a morbid interest in disrupting Defense Department equipment or else they simply figure you're some sort of hopeless intellectual wonk.

And the questions people ask! Is there an SWL in the world who hasn't been asked, "Can you talk to Russia on this thing?" Is there a ham in the world who hasn't heard, "My wife's cousin Joe in Texas has one of these radios. Do you know him?"

If you've got a CB radio you quickly learn to be very selective about mentioning this fact to random acquaintances lest you subject yourself to an unending stream of 1970's era trucker lingo. Most people seem to think that the only way they can successfully communicate with the owner of a 27 MHz radio is by liberally peppering the conversation with gems such as "That's a big 10-4, goodbuddy" and other similar golden oldies. This is often followed by the patronizing revelation that *Smokey And The Bandit* is their favorite movie.

If you are into building electronics projects or kits, you quickly learn to conceal such information from family and friends alike unless you wish to be asked to repair all manner of TV sets, toasters, and transistor portables. It's easier and far more conducive to maintaining your relationships with these good people by hiding your soldering gun under the sofa until their visit ends.

Why do you suppose electronics hobby-

ists are singled out for that little bit of extra attention?

Maybe one of the reasons is that, to many people, anybody who tinkers in any way with electrical doodads or electronics is one step removed from a medieval alchemist. Somehow, deep within the subconscious mind's memory bank, there are fragments of knowledge from primitive times that say to use a torch for light. Even though it's more than a hundred years after the invention of the light bulb, the concept of jiggling a little wall switch to cause bright light to shine from a small glass ball screwed into a table decoration is probably more than mankind can handle with ease.

Just think how it registers on this same primitive memory system when a knob is turned on the front of a box and out comes the voice of someone on the other side of the world. Only three hundred years ago it would have gotten you dragged before a witchcraft tribunal.

All of these suspicions are constantly reinforced by the media. Hollywood's archetypical evil or "mad" scientist type is always shown surrounded by rack after rack of electrical and electronics equipment. The Hollywood version of a spy is instantly identifiable by the wiretapping gear, communications equipment, and selection of other assorted high-tech electronics.

This is the interesting and rather unique—but nonetheless happy and exciting—life of the electronics hobbyist! **PC**

# It's Back! THE AMATEUR RADIO VERTICAL ANTENNA HANDBOOK

CAPT. PAUL H. LEE, USN(RET), N6PL

Capt. Paul H. Lee's *Vertical Antenna Handbook* became a classic in its first printing. Out of print for several years, this Second Edition has been brought out in response to your demand and the needs of the service. Among the topics covered are vertical antenna theory, design, installation, and construction. Specific information is given on vertical arrays, feeding and matching, short verticals, ground effects, and multiband and single-band verticals, plus there is a section that answers many of the most commonly asked questions about vertical antennas for the amateur. The Second Edition features an addendum on antenna design for 160 meters, the band that finally is coming into its own.

Order your copy now.



CQ Publishing, Inc.  
76 N. Broadway, Hicksville, NY 11801

Please rush me my copy of the 2nd Edition of *The Vertical Antenna Handbook*:

\$9.95 for the book plus \$2 for shipping & handling.

Name \_\_\_\_\_

Address \_\_\_\_\_

City \_\_\_\_\_

State \_\_\_\_\_

Zip \_\_\_\_\_

Mastercard

VISA

My account number is:





## Mailbag (from page 6)

same right to express those honest opinions as does virtually every individual ever to be a part of the electronics hobby. It always seems laughable to me that people (like Ramirez) go so quickly into a lather when someone expresses an opinion, and yet they express their own opinions without hesitation. —Editor

### Terrors Of Tinseltown

A friend insists that a few years ago you were interviewed on the radio and (possibly jokingly) mentioned that you came a long way from the days when you were "writing X-rated movies." His recollection of this alleged statement sounds absurd. I say he's bonkers, and my last name is Famiglietti, which means "always right." There's a 25-cent bet riding on your answer, so please be on the level.

Paul N. Famiglietti  
New Bedford, MA

*Big spender. I honestly don't recall ever making such a statement, but I might have said something fairly close. In 1959, as a goof, I wrote an absolutely preposterous screenplay, never expecting anything would come of it. A friend of mine read the script and said he could get somebody to produce it. I thought he was crazy, but he did it. The film was made as a piece of junk under the title of Shangri-La, starring Sammy Petrillo (a Jerry Lewis look-alike whose other screen credit was entitled Bela Lugosi Meets A Brooklyn Gorilla). By contemporary standards, Shangri-La would hardly be given an "X" rating, although by either 1960 or 1985 standards it would still be considered "Grade Z." However, in 1960 it was obviously far ahead of its time and was flatly refused an exhibition license in several states (including New York). Later it did achieve some limited release. Only a year ago, a POP'COMM reader wrote to tell me that he saw my name in the credits of "a really sleazy comedy that looked like it was shot on a bad weekend and financed with a \$10 bankroll." I therefore assume that this epic is still making the rounds in video stores somewhere. Although a low-budget film, that term used in Tinseltown still means big bucks in terms of the real word. With my earnings I was able to buy myself two goodies I wanted very badly—an exotic and legendary Black Widow radio and a Jaguar XK-150 car. You'll have to make your own decision as to who wins the 2-bits. —Editor*

### Jeeves, The Hacksaw And The Radar!

Please advise the frequency used for California smog alerts; also I'd like to know the frequency used by the California Department of Corrections.

Mark Francon  
Whittier, CA

*The air quality people operate on 39.98 MHz while the Dept. of Corrections uses 39.10 MHz. Thinking of going somewhere the next time the smog rolls in? —Editor*

# POP COMM

# BOOK SHOP

### Guide To RTTY Frequencies 2nd ed.

Details on 5500 RTTY stations/frequencies in two lists. "Real" press schedules, inside information on new RTTY techniques, etc. 192 pages, paperback, \$9.95. Order #G205.

### Radio Handbook, 22nd ed.

by Bill Orr, W6SAI  
A state-of-the-art, single source reference on radio communications and theory for hams, professional ops, techs, and engineers. New coverage includes solid state devices, Yagis and quads, and H.F. amplifier designs. A hands-on instruction manual, as well. 1168 pages, hardcover, \$39.95. Order #S197.

### The Radio Publications Group—The "Bill Orr Series"

These easy reading classics belong in the library of any active ham. Loaded with practical how-to information, with tables, charts, and formulas arranged for handy reference.

**Beam Antenna Handbook**, 200 pages, paperback, \$7.95. Order #R143.

**Wire Antennas**, 192 pages, paperback, \$7.95. Order #R144.

**Antenna Handbook**, 192 pages, paperback, \$7.95. Order #R145.

**Cubical Quad Antennas**, 112 pages, paperback, \$6.95. Order #R146.

**VHF Handbook**, 336 pages, paperback, \$11.95. Order #R147.

**Interference Handbook**, by W.R. Nelson, 247 pages, paperback, \$9.95. Order #R172.

### World Radio TV Handbook 1985

The world's only complete directory of international broadcasting and TV stations—the established, authoritative guide endorsed by the world's leading broadcasting organizations. A comprehensive country-by-country listing of short-, medium-, and long-wave stations, revised and updated to reflect actual conditions. Also includes special features on The Future Regulation of High-Frequency Broadcasting, Solar Activity in 1985, Technical Innovations at Radio Nederland's New Transmitting Station, and more. 600 pages, paperback, \$19.50. Order #B097.

### World Press Services Frequencies

by Thomas Harrington  
A comprehensive manual covering the field of radioteletype news monitoring—antennas, receivers, terminal units, monitors, and more. Contains 3 master lists of times of transmission, frequencies, plus ITU list of over 50 news services worldwide. 84 pages, paperback, \$8.95. Order #U173.

### Satellites Today: The Complete Guide To Satellite Television

by Frank Baylin  
Learn how to buy, install, operate, or even build a home satellite TV system. An overview of satellite TV written for both the non-technically educated beginner and the professional who wants to know more. It clearly explains: the history of satellite TV and electronic communication; how TV and radio messages are transmitted to and from satellites; in-depth look at how home receiving stations work; types of satellite TV and radio programs; the future of satellite TV; and much more. 160 pages, 43 illustrations, 34 photos, paperback, \$9.95. Order #CS218.

## POPULAR COMMUNICATIONS BOOK SHOP

76 N. Broadway, Hicksville, NY 11801

QTY.	ORDER #	TITLE	PRICE	TOTAL

Shipping charges \$2.00 per order. Shipping charges waived on orders of \$50.00 or more. Books shipped best way. All orders are processed the day they are received, but please allow 30 days for delivery within North America.

<b>Book Total</b>	
<b>Shipping Charge</b>	
<b>Grand Total</b>	

Order Date: \_\_\_\_\_

Name \_\_\_\_\_

Street \_\_\_\_\_

City \_\_\_\_\_ State \_\_\_\_\_ Zip \_\_\_\_\_

Check  MasterCard  VISA

Card No. \_\_\_\_\_ Expires \_\_\_\_\_

X \_\_\_\_\_

Signature required on all charge orders.

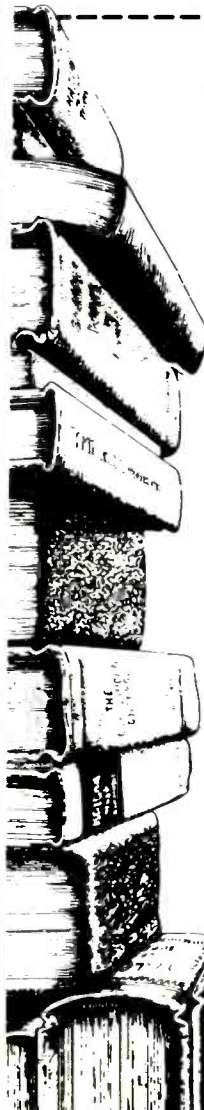

# PIRATES DEN

BY DARREN LENO, WD0EWJ

## FOCUS ON FREE RADIO BROADCASTING

**R**adio Earth, a popular international shortwave broadcaster, is raising funds to build a transmitter and studio on the Caribbean island of Curacao. Radio Earth said in a recent broadcast that airtime on the new facilities could be purchased for \$100 per hour. At least two U.S. pirates, who requested anonymity, are considering buying time on Radio Earth to air their programs.

For most pirates, \$100 is more than their yearly operating budget (for others, more than their station is worth) and it is unlikely that they would spend that much money for a relay. A more likely alternative may be to get four pirates together for a special transmission via Radio Earth and split the cost four ways. No doubt that if some pirates do decide to take to the air legally for an hour, you'll be notified in advance. They'd want as large an audience as they could get—especially when there is no risk of being caught!

Radio Earth's shortwave facility should be completed by June, 1986. If you would like to know more about it, contact Radio Earth International, Inc., Dept. PC, 1724 Sherman Ave., Evanston, IL 60201.

### Across The Dial

**KNBS:** Tom Brennan in Indiana tuned in KNBS on 7430 kHz at 0000 GMT. I stumbled over them two nights in a row—on 7436 at 0400 GMT and on 7430 at 0325 GMT. KNBS is "the free radio station that advocates the legalization of marijuana" and claims sponsorship by a group called the California Marijuana Co-operative.

**KROK:** Paul Walkendorf heard KROK begin a broadcast with the Laurel and Hardy theme music, and end it with Close Encounters. Watch for this pirate around 7430 kHz after 0130 GMT. Mail reception reports to KROK, c/o PO Box 245, Moorhead, MN 56560.

**Radio Morania, external service:** This station claims to be the official international shortwave voice for the fictitious country of Morania. It is a professional sounding, very slick production. The comedy skits, disguised as "features," included Moranian Ham Shack, a letter bag, and a "look at Moranian industry" where they visit a chocolate mine. A carefully staged signal fade-out occurs just as an address for reception reports is mentioned, surely frustrating many listeners. No one has ever received a QSL card from this station, and it is unlikely anyone ever will. Peter Bullen in Virginia recently came across Radio Morania on 15270 kHz after 1915 GMT. Steve Siggins found them on 7355 kHz at 0330 GMT.

**Radio Nova Int:** Kevin Graniero and Daniel Lieb, both in Illinois, heard this new pirate on 7410 kHz at 0200 GMT. Program-

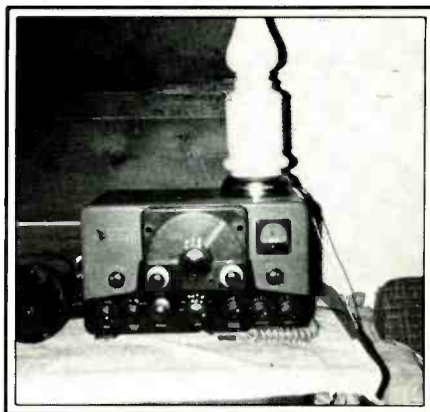

The E.F. Johnson Viking Ranger transmitter is popular among pirate broadcasters. (Photo courtesy Jonathan Scherf, WI)

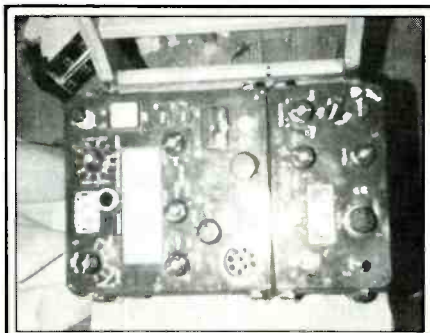

Military transceivers like this BC-1306 are tough, heavy duty radios that perform well for pirates.

ming included reggae music and comedy skits like "Mr. Reagan's Neighborhood." Preston Nevins in Michigan also heard this transmission, and assumes it was Radio Nova's first—a coincidence considering this was Preston's first pirate. Their address is PO Box 245, Moorhead, MN 56560.

**Radio Free America (WFR):** Fred Roberts in New York heard this pirate on 7355 kHz after 1207 to 1300 GMT. The announcer began identifying his station as Radio Free America, but later switched to WFR.

Fred says that more pirates should consider broadcasting in the morning. Morning transmissions are common among the European pirates. But 1207 GMT would be 7:07 a.m. on the east coast and 4:07 a.m. for our friends out west. Personally, I'm not too crazy about getting up that early, especially after listening for pirates until 2:00 a.m. that same morning.

**Radio North Coast Int:** This widely heard pirate continues to be very active. Don Mussell in Kentucky heard RNCI's "Captain Willie" as he played "weird rock music" on 7437 kHz after 0130 GMT.

**Radio USA:** This pirate was first discovered in early 1983, and has been heard faithfully ever since. Paul Walkendorf heard Radio USA on 7373 kHz as they celebrated their second year on the air. Music by Weird Al Yankovich, gag ads, a station history segment, and a satirical sports program were heard. Reception reports for this pirate can be sent to Radio USA, c/o PO Box 5074, Hilo, HI 96720.

**Radio Woodland Int:** Norman Driskell in Rhode Island "finally" heard a pirate station—RWI on 7431 kHz at 0010 GMT. I also heard RWI, but on 7430 kHz after 0345 GMT. This station also identifies as the Voice of Nature. Mail reception reports to WRI, c/o PO Box 5074, Hilo, HI 96720.

**Samurai Radio:** This pirate, once a regular find, seems to have slashed their operating schedule. Terry Palmersheim in Minnesota caught one of their infrequent broadcasts on 6275 kHz after 0415 GMT.

**Union City Radio:** John Arthur in Hawaii heard them on 7435 kHz from 0530 until 0615. The next day, I heard a Morse code beacon on 7430 kHz that sent "Union City Radio" repeatedly after 0415. Their address is UCR, c/o PO Box 5074, Hilo, HI 96720.

**Voice of To-morrow:** There is a rumor circulating that the VOT may soon be ending their transmissions, but as of this writing, they are still being heard. This pro-sounding, but controversial political pirate was logged recently by Fred Roberts on 7410 kHz after 2300 GMT. Send mail for this pirate to Box 20039, Ferndale, MI 48220.

**Voice of Venus:** I tuned in the Voice of Venus on 7430 kHz at 0045 GMT. The show included new wave/punk music and talk from announcer Scott Wild. The details of the program match up with one heard last January, leading me to believe this was a repeat of an earlier taped show.

**WMTV** Ken Evans in South Carolina heard WMTV on 7428 kHz at 0128 GMT. The pirate announced a phone number, which Ken called. He reached an answering ma-

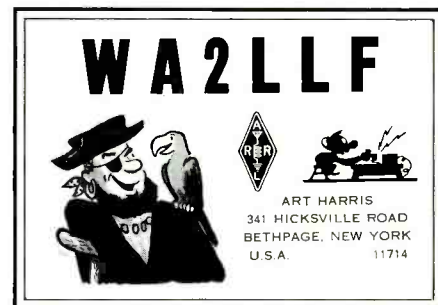

"Thought you might enjoy this 'pirate' QSL. This was my first ham QSL and was, of course, completely legitimate." Art Harris, now N2AH.





This QSL is Chuck Vesei's reward for hearing Radio Tabasco. He sent his reception report to Box 982, Battle Creek, MI 49016.

chine that asked him to leave a request for a record at the tone. The address announced was WMTV, c/o John, PO Box 1945, Del Ray Beach, FL 33444.

**WSWL – Voice of the Purple Pumpkin:** “The broadcasting service of the ever expanding increasing incorporated enterprises of the Purple Pumpkin” was heard by Robert Horvitz, DC, on 7433 kHz at 1940 GMT. The Purple Pumpkin has a history that goes back to the late 1960’s. The original station was closed by the FCC on July 31, 1974. Some pirates will occasionally use the name of the popular old pirate to keep the legend of the Purple Pumpkin alive (see the February, 1985 edition of *The Pirates Den* for a more detailed description of this pirate).

### Reader Feedback

Dear Darren,

I'd like to draw your attention to an inaccuracy in your column about broadcasting in Britain.

First, there is no “government monopoly” in broadcasting. The BBC is a Public Corporation set up by Royal Charter and does not carry advertising—it is financed by TV set owners paying a license fee of about \$67 U.S. dollars. In return for this fee, there are two national TV channels, four radio services and 32 local radio stations.

As for the TV channels—the country is divided into about a dozen areas, each area with its own TV company. On one of our two channels, programs from the local TV stations are networked, while the other independent channel commissions programs from a variety of sources, including the local TV companies.

There are also 50 commercial local radio stations, each transmitting on FM and AM. I hope this sheds some light on broadcasting here and if you would like to know more, don't hesitate to ask.

Sincerely, Nick Richardson, Aylesbury, Bucks, England.

Thanks for your comments, Nick. They were well received and appreciated. In the United States, where we have three national television program networks (with another

being planned by international media mogul, Rupert Murdoch), and several national radio networks, it's hard for us to picture a “Public Corporation set up by Royal Charter” and financed by viewers as not being a monopoly. But as Americans have discovered, more networks do not necessarily mean better programming. U.S. networks have shown us time and time again that they are more concerned with “ratings” than quality. With millions of people subscribing to cable radio and television to escape the “monopoly” of U.S. commercial broadcasters, we see that many Americans are willing to pay to be free of television shows like *Family Feud* and *The Love Connection*.

Then there are people, both in England and the United States, who start illegal radio and television stations—confident that they can be more entertaining than the commercial giants or local network “affiliates.” In some cases they are; in others, they are not. But of course, that depends on your individual taste. Maybe you enjoy *Family Feud*.

### In Conclusion . . .

A few pirates have been announcing the Pirates Den as a QSL address to their listeners. I have received several reports for different stations, but have no idea what to do with them. I'd like to ask readers not to send me mail to forward to pirates. I encourage the pirates to seek out the mail drops other stations use. It's not fair to your listeners to make them send reports that you won't read. Mail for pirates sent to this column will not be forwarded.

Most pirate broadcasters take to the airwaves weekend evenings. Use the times and frequencies in this column to aid you in your search. Anyone willing to give up a Friday or Saturday evening to monitor the “pirate band” of 7350 kHz to 7450 kHz stands a good chance of hearing some of the stations mentioned here. Don't forget to report back to me what you've heard. I also appreciate receiving copies of QSL cards, pennants, and information sheets that you receive from pirates, as well as any news clippings, ideas, tips, or experiences that you would like to share with thousands of other *Popular Communications* readers. My address is The Pirates Den, c/o Popular Communications, 76 N. Broadway, Hicksville, NY 11801. I hope I'll hear from you next month. **PC**

CALL TOLL FREE FOR QUOTES  
**1-800-328-0250**  
1-612-535-5050  
(IN MINNESOTA—COLLECT)

## Kenwood Receiver Special Deals!

**R600 \$289 R1000 \$389 R2000 \$449**

**ICOM R71A World Class Receiver \$629**

**HEIL SS-2 Amplified Speaker \$48<sup>95</sup>**

**EAVESDROPPER Antenna \$54<sup>95</sup>**

**We deal in receivers and transceivers for all applications.**

VISA/MASTER CARD  
FREE SHIPPING  
ON MOST RIGS FOR CASH!



S.A.S.E. FOR OUR  
“BENCH-TESTED”  
USED EQUIPMENT LISTING

MON-FRI 9 AM - 6 PM CENTRAL TIME  
SATURDAY 9 AM - 5 PM

**4124 West Broadway, Robbinsdale, MN 55422 (Mpls./St. Paul)**

CIRCLE 80 ON READER SERVICE CARD

# COMMUNICATIONS SHOP

**Advertising Rates:** Non-commercial ads are 30 cents per word including abbreviations and addresses; minimum charge \$6.00 per issue. Ads from firms offering commercial products or services are \$1.00 per word; minimum charge \$20.00 per issue. Leading key words set in all caps at no additional charge. All classified ads must be prepaid in full at time of insertion; a 5% discount is offered for prepaid 6 time insertions. All ads must be typewritten double spaced.

**Approval:** All ad copy is subject to Publisher's approval and may be modified to eliminate references to equipment and practices which are either illegal or otherwise not within the spirit or coverage scope of the magazine.

**Closing Date:** The 10th day in the third month preceding date of publication. Because the advertisers and equipment contained in Communications Shop have not been investigated, the Publisher of Popular Communications cannot vouch for the merchandise listed therein. Direct all correspondence and ad copy to: PC Communications Shop, 76 N. Broadway, Hicksville, NY 11801.

HX-1000 MOBILE CHARGER CORD plugs into cigarette lighter, recharges your scanner in the car. Only \$12.50 postpaid. MC/VISA OK. ESS/Denver, Box 147, Aurora, CO 80040.

## Cellular Mobile Scanners

Made By Regency

**HX2000 Handheld, 7 Bands \$335**

**MX4000 Home/Mobile, 8 Bands \$325**

**MX7000 Home Scanner, continuous**

**coverage 25 - 550 MHz, .8-1.3 GHz \$415**

Add \$7 for UPS shipping, NJ res. add 6% tax

Certified Check or Money Order only

Mail Orders to: "OK" Pollack Audio

303 Long Avenue Hillside, NJ 07205

(201) 687-7780

CIRCLE 70 ON READER SERVICE CARD

## Shortwave Receivers, Antennas

ICOM - KENWOOD - YAESU Etc.

Call 212-925-7000

Open 7 days a week, Mon.-Fri. 9am-6pm,

Thurs. until 8pm, Sat. & Sun. 10am-5pm

## Bary Electronics

512 Broadway • New York, NY 10012

Sales & Service Ham & Commercial Radio

For 35 Years

Please send all reader inquiries directly.

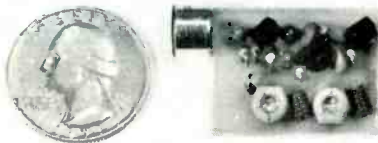

## THE MOST EXCITING KIT YOU WILL EVER BUILD

The model WAT-50 miniature FM transmitter uses a 4-stage circuit NOT to be confused with a simple wireless microphone. Up to 1 mile range. So sensitive, it can pick-up a person whispering 50 feet away! Use with any FM radio. Complete kit only \$29.98. Tax included. FREE SHIPPING.

**DECO INDUSTRIES**

**BOX 607**

**BEDFORD HILLS, NY 10507**

Available only as a kit in the U.S.

CIRCLE 112 ON READER SERVICE CARD

TELL YOUR VISUALLY HANDICAPPED FRIENDS about our catalog tape of radios modified for the blind. \$2.00. FM Atlas. Adolph, MN 55701-0024.

SWL PACKAGE: Kenwood R-600, Yaesu YH-55 SWL headphones, 1985 WRTH, many accessories, like new, original boxes, \$250. Box 983, Medford, OR 97501

"FREE PRE-TESTING!!" HX-1000 \$224.50, HX-2000 \$289.50, MX-7000 \$439.50, BC-50XL, BC-100XL, BC-800XLT. IN STOCK!! ICR-71/A \$649.50, R-2000 \$459.50, R-1000 \$399.50 25 page picture catalog \$1.00 (refundable). GALAXY ELECTRONICS, Box 1202, 67 Eber Ave., Akron, Ohio 44309. (216-376-2402) 9-5pm EST.

FREDERICK 1500A RECEIVER \$375. Frederick 1200 F.S.K. Demodulator \$350, T.M.C. Radio Transmitter G.P.T. (750-C-Z) \$395, T.M.C. - Antenna Tuning System - 2A'50 - (An-URA-27) \$375, all including original manual & mint condition. Hammarlund S.P. 600 receiver \$195. National 400M receiver \$175, good conditions & manual. Raul L. Martinez, 9205 SW 9 Terrace, Miami, FL 33174.

FCC Commercial General Radiotelephone License Correspondence Course. 60 individual lessons for \$89.50. Payment plan. Results guaranteed! Details free. AMERICAN TECHNICAL INSTITUTE, Box 201, Cedar Mountain, NC 28718.

CABLE TV CONVERTERS & EQUIPMENT. Plans and parts. Build or buy. FREE information. C&D Electronics, 626 Flowerdale, Dept. PC, Ferndale, MI 48220.

AMERICA'S NATIONAL RECREATIONAL LANDS FREQUENCY GUIDE—Includes forests, parks, monuments, much more. \$10. CP Communications, Box 997, Las Vegas, Nevada 89125.

CUSTOM ETCHED GLASS PLAQUES OR SIGNS for your club's logo or anything else on mirror, clear glass, stone, wood, mugs, plates, wine glasses, anything. RISING SUN, Dept. 719, 315 Holstein St., Bridgeport, PA 19405.

EARN \$800+ WEEK! Get your "F.C.C. General Radiotelephone License."—Fast, inexpensive! Electronics Home Study. "Free" details. Command, D-216, Box 2223, San Francisco 94126.

EQUIPMENT: Security, Privacy, Police, Surveillance, Countermeasures, Telephone. BOOKS: Plans, Secret Reports, Forbidden Knowledge. Send \$10.00 for large catalog and one year updates. SHERWOOD COMMUNICATIONS, 2789 Philmont Avenue, Suite #108PC, Huntingdon Valley, PA 19006.

NATIONAL ORGANIZATION OF SCANNER OPERATORS: Non-Profit! Protecting rights of scanner owners. Newsletters, UNBIASED test results, NO Advertising! FREE Nation-wide frequency directory! Membership—\$9.00/year. NOSO, Box 3047-PC, Greenville, NC 27836-3047.

FREE CB MODIFICATIONS catalog! Frequencies, sliders, FM, amplifiers, books, kits, repairs, high-performance accessories. CBCL, Box 31500PC, Phoenix, AZ 85046 (602) 996-8700.

SURVEILLANCE RECEIVER, LTV G-175. 30 to 260 MHz, AM, FM, CW, variable bandwidth, late 60's vintage, good condition, 115 VAC, 24 lb., \$275.00 plus UPS. Frank Moreland, 3748 Yosemite, San Diego, CA 92109.

SATELLITE TV: Are you missing 24-hour quality entertainment? Better than Cable. 9' system \$895.00 up. COD available. 1-800-826-6700 ext 200.

CABLE CONVERTERS TO SCRAMBLERS. Lowest price. Dealer inquiries accepted. Quantity discounts. Free catalog. P.G. Video Corp., 61 Gatchell St., Dept. PC, Buffalo, NY 14212.

BUILD YOUR OWN SATELLITE TV Receiving System and save! Instruction manuals, schematics, circuit boards, parts kits! Send stamped envelope for complete product listing. XANDI, Box 25647, Dept. 31D, Tempe, AZ 85282.

POLICE & FIRE SCANNERS. Special—Regency D-310, 30 Channel Digital Scanner \$129.99 plus \$4.50 shipping. See Our Full-Page Ad in This Issue for Complete Description. Free Catalog Available. SCANNER WORLD, USA, 10 New Scotland Ave., Albany, NY 12208, phone 518-436-9606.

PANARAMIC ADAPTER, Watkins-Johnson SM8512.6, 455 kHz IF Input, 5 kHz, 20 kHz, 50 kHz spread. Excellent condition \$395.00. Frederick 1203 Variable Shift RTTY Demodulator. The best! \$395.00. Excellent condition. Frederick 1202 Fixed 850 Hz Shift RTTY Demodulator. \$125.00. Frederick 1500A receiver. Crystal controlled. \$360.00. Tektronics 3L5-R564B-2B67 Spectrum Analyzer. \$600.00. HP 3330 B Automatic Synthesizer. \$1800.00. Joe Jesson. 21414 W. Honey Lane, Lake Villa, IL 60046. (312) 356-6817.

NEW! AIR-SCAN 4th Edition by Tom Kneitel. At last, a complete directory of aero communications stations/frequencies! Now in gigantic 120 page large-size (8 1/2 x 11) format containing 40,000 listings (USA/Canada/Mexico/PR), including worldwide HF (2-30 MHz) freq. guide. In addition to 118-136 MHz VHF aero band scanner listings, also covers 30-50, 138-174, & 400+ MHz aero freqs. never before published. AIR-SCAN covers civilian/military airports, also "unlisted" airports not open to public, FAA freqs, FSS, towers, Unicom, airport security and operations freqs, new airborne air/ground telephone freqs, "hidden" business-band aero stations, military, traffic choppers, aero weather, federal agency aero, flight schools, aircraft mfrs., crop dusters, air ambulances and much more throughout USA. Largest directory of all-band aero radio communications ever published. Includes how-to text on aero monitoring and equipment selection. Only \$10.95 + \$1 shipping to USA/Canada/APO/FPO. Order from CRB Research, P.O. Box 56, Commack, NY 11725.

COMMUNICATIONS PLANS, KITS, BOOKS. 1750 Meter transceivers, AM/FM broadcast transmitters, ham/CB amplifiers, surveillance bugs, much more! Catalog \$1.00. PAN-COM, Box 130-PC11, Paradise, CA 95969.

CLANDESTINE CONFIDENTIAL keeps you up to date on the latest in clandestine broadcasting. 6 issues per year \$10 in the U.S., \$13 foreign. G.L. Dexter, RR4 Box 110, Lake Geneva, WI 53147.

JOIN A RADIO listening club. Complete information on major North American clubs for 25¢ and SASE. Association of North American Radio Clubs, 1500 Bunbury Drive, Whittier, CA 90601.

NORTH AMERICAN RADIO-TV STATION GUIDE by Vane Jones. Brand new 15th Edition! Thick 226-page book listing all US/Canadian/Mexican/West Indies AM/FM/TV broadcasters according to location/frequency/callsign, plus TV network affiliation, AM station day/night power, schedule data, etc. Painstakingly complete, accurate, up-to-date. The ultimate broadcast station directory. Only \$9.95 (plus \$1 postage) from CRB Research, P.O. Box 56, Commack, NY 11725.



# AD INDEX

COMPUTER PROGRAMS for Commodore 64. Menu driven providing logs for BCL/SWL. Update formats, QSL records, other. Disk or tape. Screen and/or printer. Send SASE for more info & sample printout. Manucy, P.O. Box 5624, Baltimore, MD 21210.

WANTED! OLD MAGAZINES: Shortwave Craft, Radex, Radio Broadcast, Radio World, and Short Wave Radio, pre-1950 non-ham callbooks, station directories and QSL cards. Specify prices. Box NFP, Popular Communications magazine, 76 North Broadway, Hicksville, NY 11801.

RECEIVERS FOR SALE: (1) Power Supply, runs (4) R-392 receivers, \$50; (1) Regency Executive Scanner, 16 channel 30-50/150-175/450-470 MHz w/20 30-50 A.F. Air-Air Xtals and manual. \$100; (1) T.M.C. SBE-3 2-32 MHz 1 watt exciter w/PP-1769 power supply and mic, \$125; (2) T.M.C. PMO-1 2-8 MHz 5 watt oscillator, \$75 each; (6) R-1121/TRC-87 manual (receiver only), \$50 each. For information call 419-726-2249.

ARMY FIELD RADIOS: CPRC-26 Infantry Manpack Radio. compact, transmits-receives 46-54 MHz FM, 6 channels. with battery box. antenna, crystal, handset. \$22.50 apiece, \$42.50/pair. good condition. PRC-9 Backpack Radio. factory mint, transmits-receives 28-39 MHz FM continuous tuning: \$52.50 apiece. \$77.50 with good condition battery box, antenna, handset. PRC-510 Backpack Radio (Canadian version of American PRC-10). transmits-receives 38-55 MHz FM continuous tuning, with battery box, antenna, handset: \$39.50 apiece, \$77.50/pair, good condition. R-390A Communications Receiver. 5-32 MHz AM-CW-SSB, shortwave. amateur, military frequencies: \$175 good condition. R-108 Military Vehicle/Field Receiver, 20-28 MHz FM: \$27.50 mint. 45 day replacement guarantee. Add \$9.50 shipping-handling. Baytronics, Dept. PC, Box 591, Sandusky, OH 44870.

ELECTRONIC SPYING is the name of the game. It's also the title of a startling book which reveals the closely guarded methods & equipment used by professionals & amateurs who eavesdrop on homes & businesses with (sometimes) legal and (usually) illegal bugs & wiretaps. Written in non-technical language everyone can easily understand, ELECTRONIC SPYING has photos & illustrations clearly revealing exactly how they do it & where they get the equipment (much of it inexpensive & easily available). Leaves nothing to the imagination! Latest techniques covered & offers an in-depth wealth of information on the ever increasing electronic invasion unavailable from any other source. This book is used by law enforcement agencies as a reference manual. Only \$7.95 (plus \$1.00 postage) per copy from CRB Research, P.O. Box 56, Commack, N.Y. 11725.

SCANNER OPERATORS! Are you registered? Be assigned your own personal monitoring ID letters inscribed on beautiful 2-color bordered certificate. Thousands already registered! Only \$5, ppd. from CRB Research, Box 56PC, Commack, NY 11725.

WORLD'S MOST UNUSUAL Communications Books! A large selection of outstanding titles covering scanners, "confidential" frequency registries, bugging, wiretapping, electronic surveillance, covert communications, computers, espionage, monitoring, and more! New titles being added constantly! Ask for our large new FREE catalog. CRB Research, Box 56-PC, Commack, NY 11725.

NEW! TOP SECRET REGISTRY OF U.S. GOV'T FREQUENCIES by Tom Kneitel. Yes. it's finally here! The NEW 5th Edition is now 168 pages BIG in large 8 1/2" x 11" format (same page size as POP/COMM). Latest federal scanner frequency listings for FBI, FCC, Border Patrol, ATF, Immigration, Secret Service, CIA, Customs, Coast Guard, Armed Forces, and much more. Tens of thousands of call signs, frequencies, locations. The ultimate scanner directory also reveals many HF listings plus complete historic roster of all federal land stations authorized in 1923 (60 years ago!). New 5th Edition is \$14.95 postpaid by Book Rate Mail, or add \$2 if First Class Mailing wanted. Order your copy now! CRB Research, P.O. Box 56, Commack, NY 11725.

CASH PAID FOR USED SPEED (TRAFFIC) RADAR EQUIPMENT. Write or call: Brian R. Esterman, P.O. Box 8141, Northfield, Illinois 60093, (312) 251-8901.

ARRL .....	55
Allied App. & Radio .....	67
All Electronics .....	37
ARCsoft Publishers .....	14
Barry Electronics .....	74
Butternut Electronics Co. ....	11
CBC International .....	61
C.O.M.B. ....	65
CRB Research .....	40
Capri Electronics .....	15
Communications Elect. ....	2
Computer Trader .....	61
ConSol .....	67
Copper Electronics .....	33
DNE, Inc. ....	67
Deco Industries .....	75
Delaware Amateur Supply .....	53
Dog House .....	74
EGE, Inc. ....	7
Electronic Center, Inc. ....	51
Electronic Equipment Bank ..	22, 23
Golden State Communications ..	53
Ham Station .....	11
Hamtronics, Inc. ....	49
Hardin Electronics .....	53
Hustler, Inc. ....	21
ICOM America, Inc. ....	Cov.IV
JoGunn Ent. ....	55
Kenwood .....	Cov.II
MFJ Enterprises, Inc. ....	4
Madison Electronics .....	75
Metz Comm. Corp. ....	37
Microlog Corp. ....	21
Morning Distributors .....	19
OK Pollack Audio .....	74
Panasonic .....	5
PopComm Book Shop .....	71
Radio West .....	51
SATMAN .....	25
SSD .....	53
Satellite Express .....	51
Scanner World, USA .....	1
Signal Engineering .....	39
Smith Electronics, Dick. ....	39
Spectronics .....	76
TNT Radio Sales, Inc. ....	73
Universal SW Radio .....	33, 57
Van Valzah Co. ....	51
Yaesu Electronics .....	Cov.III

Reach this dynamic audience with your advertising message, contact Herb Pressman at (516) 681-2922.

## MADISON Electronics Supply

3621 Fannin St.  
Houston, TX. 77004  
Call for Quotes  
1-800-231-3057

Texas Number:  
1-713-520-7300



**ICOM**



**IC-R7000**

Commercial quality scanning receiver 25-1300 MHz plus, keyboard entry, 99 memories, 5 tuning speeds. Call for \$\$\$

### ANTENNAS

MADISON stocks antennas from most MAJOR ANTENNA MANUFACTURERS. Examples:  
BARKER & WILLIAMSON  
TRAP DIPOLE 41.50  
METZ base loaded whip 59.95  
McKAY DYMEK active antennas CALL  
ROHN TOWERS CALL

### SPECIAL - BUTTERNUT ANTENNAS

SC-3000 30 to 512 MHz SCANNER ANT	58.95
SWL DIPOLE stub tunned, low loss 2 to 30 MHz	38.95
HF6V 80, 40, 30, 20, 15 & 10 meter vertical	124.95
HF2V 80 & 40 meter vertical	124.95
ACCESSORIES IN STOCK	CALL

### POLICIES: MASTERCARD - VISA - COD

All prices FOB Houston, TX except as noted. Prices subject to change without notice, subject to prior sale. Used gear sale price refunded if not satisfied. Texas residents subject to sales tax.

CIRCLE 54 ON READER SERVICE CARD

- Scanner Memory Expansion Units
  - Scanner Signal Strength Meters
  - Scanner Direction Finders
  - Scanning Transceivers
- 200 channel, 134-174 & 421-512 MHz user programmable

THE DOG HOUSE

P.O. Box 511  
Fairfax, VA 22030  
(703) 280-5072

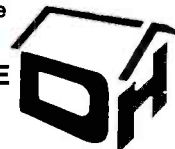

A Regency dealer

# ICF-2010 \$289.95

Plus \$3.00 UPS

LIST \$349.00 1985 catalog price \$299.00

## TECHNOLOGY FEATURES

- **Dual PLL quartz frequency synthesis** — the world's most accurate tuning system; uses a quartz crystal's accuracy to abolish drift and maximize tuning stability
- **New synchronous detection circuitry** for the first time in a consumer radio; dramatically reduces fading and annoying "beat" frequency interference from adjacent stations
- **Switchable IF bandwidth**, "narrow" to select one station out of a crowded band, or "wide" for the lowest distortion when your station isn't fighting to break through the clutter
- **Built-in ferrite bar antenna** for LW and MW reception
- **Telescopic antenna** for FM and SW reception

## SPECIFICATIONS

**Frequency Range:** AM: 150-29,999.9 kHz; FM: 76-108 MHz; Air: 116-136 MHz

**Antenna System:** LW, MW: Built-in Ferrite Bar Antenna; FM, Air, SW: Telescopic Antenna

**Inputs:** DC-In 4.5V, External antenna input (minijack x 2)

**Outputs:** Earphone (minijack); Record output (minijack)

**Speaker:** 4-inch dynamic

**Power Requirements:** Batteries "D" x 3 (4.5V) (optional); "AA" x 2 (3V) (optional) for programmable clock/timer; AC 120 Volts, 60 Hz with AC Adaptor (supplied); DC-12 Volts with DCC-127A Car Battery Cord (optional)

**Dimensions:** 6 1/4" H x 11 3/8" W x 2 1/8" D

**Weight:** 3 lbs., 12 oz. (with batteries inserted)

**Color:** Black

**Supplied Accessories:** AC Adaptor; Earphone; Shoulder Strap; Long Wire External Antenna; External Antenna Connector (x 2); Short Wave Handbook

**Optional Accessories:** DCC-127A Car Battery Cord; AN-1 Active Antenna



**NEW! SONY RECEIVER**

## CONVENIENCE FEATURES

- **Full AM band coverage (LW, MW, SW, USB, LSB) plus FM and Air Band reception**
- **Band select** function for quick access to SW broadcast bands
- **Direct Access™** tuning enables you to "key-in" station numbers directly
- **Rotary tuning knob** for smooth, convenient manual tuning up and down the band
- **32 station memory presets** for immediate recall at the touch of a button
- **Memory Scan tuning** gives a brief sampling of each preset

- **Automatic Scan tuning** gives a brief sampling of each station on the band
- **Built-in quartz clock** with standby and alarm capability
- **Programmable timer** turns receiver on and off automatically up to four times per day, tuning in up to four different stations
- **Sleep timer** for 15, 30, or 60 minutes of music as you go to sleep
- **Switchable 12-hour/24-hour clock** indication; 24 hour indication facilitates reference to Greenwich Mean Time (GMT)
- **Multi-function liquid crystal display (LCD)** indicates tuned frequency, preset station number, AM (LW, MW, SW) or FM, shortwave meter band, and more

## NEW! 9 BANDS IN THE PALM OF YOUR HAND

### SONY ICF-4910

- 13, 16, 19, 25, 31, 41, 49mtr SWL
- Dual Conversion
- AM & FM Broadcast
- Small Size ... only 2 15/16" x 5 1/4" x 7/8"
- Ideal for the traveler!

ONLY **\$89.95** + \$3.00 UPS



## Panasonic Command Series



- Advanced microcomputer-controlled tuner
- PLL quartz-synthesized
- Double superheterodyne system
- RF-B600.....\$424.95 + S.H.
- RF-B300.....\$199.95 + S.H.
- RF-3100.....\$269.95 + S.H.

The new Sony ICF-2002 is here! From one of America's largest Sony SWL dealers.

Reg. \$249.95

SPECIAL **\$199.95**

Plus \$3.00 UPS



**AVAILABLE NOW!**

## SUPER SALE!

Factory price break allows us to pass the savings on to you! Our lowest price yet!

### FEATURES

Ten memory channels • 12/24 hour quartz clock • PLL tuning for drift-free performance • Dual conversion Superheterodyne for high sensitivity • SSB/CW

### SPECIFICATIONS

150 kHz-30 MHz AM, 76-108 MHz FM • 1 uV sensitivity @ 6 dB S/N @ 10 MHz • 72 dB @ 10 MHz image ratio • 3 kHz @ -6 dB

## FAMOUS "EAVESDROPPER" SWL RECEIVING ANTENNA



ONLY **\$59.95**

+ \$3.00 UPS

- Automatic bandswitching
- Completely weatherproof
- 60,49,41,31,25,19,16,13 & 11mtrs.
- Complete, no assembly needed



**SPECTRONICS** INC

1009 GARFIELD STREET, OAK PARK, IL 60304

(312) 848-6777







# Yaesu has serious listeners for the serious listener.

Yaesu's serious about giving you better ways to tune in the world around you.

And whether it's for local action or worldwide DX, you'll find our VHF/UHF and HF receivers are the superior match for all your listening needs.

**The FRG-9600. A premium VHF/UHF scanning communications receiver.** The 9600 is no typical scanner. And it's easy to see why.

You won't miss any local action with continuous coverage from 60 to 905 MHz.

You have more operating modes to listen in on: upper or lower sideband, CW, AM wide or narrow, and FM wide or narrow.

You can even watch television programs by plugging in a video monitor into the optional video output.

Scan in steps of 5, 10, 12½, 25 and 100 KHz. Store any frequency and

CIRCLE 19 ON READER SERVICE CARD

related operating mode into any of the 99 memories. Scan the memories. Or in between them. Or simply "dial up" any frequency with the frequency entry pad.

Plus there's more, including a 24-hour clock, multiplexed output, fluorescent readout, signal strength graph, and an AC power adapter.

**The FRG-8800 HF communications receiver. A better way to listen to the world.** If you want a complete communications package, the FRG-8800 is just right for you.

You get continuous worldwide coverage from 150 KHz to 30 MHz. And local coverage from 118 to 174 MHz with an optional VHF converter.

Listen in on any mode: upper and lower sideband, CW, AM wide or narrow, and FM.

Store frequencies and operating modes into any of the twelve channels for instant recall.

Scan the airwaves with a number of programmable scanning functions.

Plus you get keyboard frequency entry. An LCD display for easy readout. A SINPO signal graph. Computer interface capability for advanced listening functions. Two 24 hour clocks. Recording functions. And much more to make your listening station complete.

**Listen in.** When you want more from your VHF/UHF or HF receivers, just look to Yaesu. We take your listening seriously.

## YAESU

**Yaesu Electronics Corporation**  
6851 Walthall Way, Paramount, CA 90723  
(213) 633-4007

**Yaesu Cincinnati Service Center**  
9070 Gold Park Drive, Hamilton, OH 45011  
(513) 874-3100



Dealer inquiries invited.

Prices and specifications subject to change without notice.  
FRG-9600 SSB coverage: 60 to 460 MHz.



ICOM 25-1300MHz Plus!

# IC-R7000



## ICOM's commercial quality scanning receiver...Top quality at a gem of a price.

ICOM introduces the IC-R7000 advanced technology 25-2000MHz\* continuous coverage communications receiver. With 99 owner programmable memories, the IC-R7000 covers low band, aircraft, marine, business, FM broadcast, amateur radio, emergency services, government and television bands.

**Keyboard Entry.** For simplified operation and quick

tuning, the IC-R7000 features direct keyboard entry. Precise frequencies can be selected by pushing the digit keys in sequence of the frequency or by turning the main tuning knob.

**99 Memories.** The IC-R7000 has 99 memories available to store your favorite frequencies, including the operating mode. Memory channels may be called up by simply pressing the Memory switch, then rotating the memory channel knob, or by direct keyboard entry.

**Scanning.** A sophisticated scanning system provides instant access to most used frequencies. By depressing the Auto-M switch, the

IC-R7000 automatically memorizes frequencies in use while the unit is in the scan mode. This allows you to recall frequencies that were in use.

### Other Outstanding Features:

- FM wide/FM narrow/AM/upper and lower SSB modes
- Six tuning speeds: 0.1, 1.0, 5, 10, 12.5 or 25KHz
- Dual color fluorescent display with memory channel readout and dimmer switch
- Compact Size: 4-3/8"H x 11 1/4"W x 10 7/8"D
- Dial lock, noise blanker, combined S-meter and center meter

- Optional RC-12 infrared remote controller
- Optional voice synthesizer. When recording, the voice synthesizer automatically announces the scanned signal frequency.

\*Specifications guaranteed from 25-1300MHz. No additional module required for coverage to approximately 2.0GHz.

See the IC-R7000 receiver at your local authorized ICOM dealer. Also available is the IC-R71A 0.1-30MHz general coverage receiver.

**ALL THIS AT A PRICE YOU'LL APPRECIATE.**

CIRCLE 178 ON READER SERVICE CARD



**First in Communications**

ICOM America, Inc., 2380-116 Ave NE, Bellevue, WA 98004 / 3331 Towerwood Drive, Suite 307, Dallas, TX 75234  
All stated specifications are approximate and subject to change without notice or obligation. All ICOM radios significantly exceed FCC regulations limiting spurious emissions. R7000BBS